











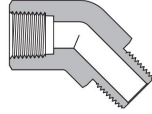

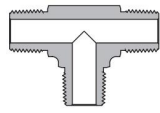
Pipe Fittings

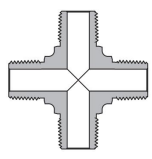

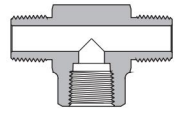
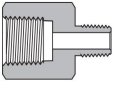
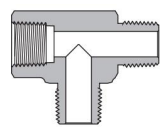
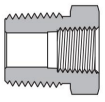
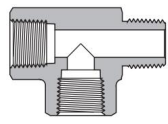
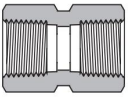
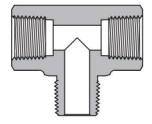
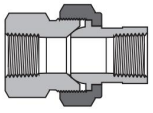
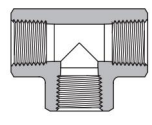
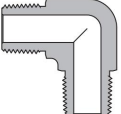
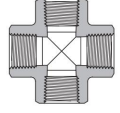
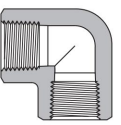
ROKE
Valves and Fittings

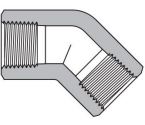
www.chinaroke.com

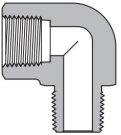
Contents

Hex Nipples -THN	01	45° Street Elbows - TSV	16
			
Hex Long Nipples -HLN	04	Male Tees -TMT	17
			
Closed Nipples - TCN	05	Male Crosses -TMC	18
			
Special Pipe Nipples -SPN	05	Female Brunch Tees - TFB	18
			
Adaptors - TAD	06	Female Run Tees - TFR	19
			
Reducing Bushings -TRB	09	Male Street Tees - TMS	19
			
Hex Couplings -THC	10	Male Brunch Tees - TMB	20
			
Union Ball Joints -TUB	11	Female Tees - TFT	21
			
Male Elbows - TME	12	Female Crosses -TFC	22
			
Female Elbows - TFE	12	Pipe Caps - TPC	22
			
45° Female Elbows - TFV	13	Pipe Plugs - TPP	23
			
Street Elbows - TSE	14	Hollow Hex Plugs -HHP	23
			

Features

- ⦿ All fittings have a high-quality appearance.
- ⦿ Every fitting is marked with manufacturer’s name for easy source tracing.
- ⦿ Male threads are capped for protection.
- ⦿ Straight fittings are manufactured from quality bar stock for strength
- ⦿ Shaped fittings are manufactured from forgings.

Materials

Designator	Material	Bar Stock	Forged
SS	Stainless Steel 316	ASTM A276	ASTM A182
S4	Stainless Steel 304	ASTM A276	ASTM A182
CS	Carbon Steel	ASTM A108	ASTM A105
B	Brass	ASTM B16/B453	ASTM B283
AL	Aluminum	ASTM B211	ASTM B247

Plating and Coating

To resist corrosion, all carbon steel fittings are treated with an electrodeposited zinc plating.

Thread Specifications

Thread Type	Specification
NPT	ASME B1.20.1, SAE AS71051
ISO/BSP (parallel, based on DIN 3852) RP and RS fittings	ISO 228, JIS B0202
ISO/BSP (tapered, based on DIN 3852) RT fittings	ISO 7/1, BS EN 10226-1, JIS B0203
ISO/BSP (gauge) (based on EN 837-1 and 837-3) RG fittings	ISO 228, JIS B0202
Unified (SAE) ST fittings	ASME B1.1

Working Pressure

For the working temperatures of ROKE pipe fittings, refer to the Pipe Fittings catalog.

Temperature Ratings

Fitting Materials		Gasket, O-Ring Materials		
Material	Max Temperature	Material	Max Temperature	Mini Temperature
stainless steel	1000 °F / 537 °C	Buna N	230 °F / 110 °C	-13 °F / -25 °C
Carbon steel	375 °F / 190 °C	Fluorocarbon FKM	400 °F / 204 °C	-20 °F / -28 °C
Brass	400 °F / 204 °C	Copper	400 °F / 204 °C	-325 °F / -198 °C

Part NO. Discription

For Example: **SS-THN-MN 8-MN 4**

Material	Series	Thread Type :	Thread Size	Thread Type :	Thread Size
SS: SS 316		FN: Female Npt	2: 1/8"	FN: Female Npt	2: 1/8"
S9: SS 904L		MN: Male Npt	4: 1/4"	MN: Male Npt	4: 1/4"
S4: SS 304		FR: Female BSPT	6: 3/8"	FR: Female BSPT	6: 3/8"
M4: Monle 400		MR: Male BSPT	8: 1/2"	MR: Male BSPT	8: 1/2"
B: Brass		SAE: UNF	12: 3/4"	SAE: UNF	12: 3/4"
CS: Carbon Steel			16: 1"		16: 1"

1 Pipe Fittings

Hex Nipples

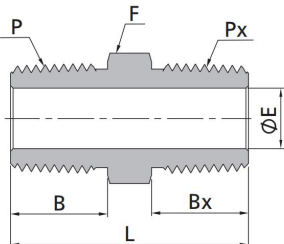

Male NPT Threads									
P-NPT Size	Px-NPT Size	Basic Ordering Number	Dimension,in(mm)					Working Pressure psig(bar)	
			L	F (Hex)	B	Bx	E	316SS, Steel	Brass
1/16	1/16	-THN-MN1	1.01 (25.6)	0.31 (7.9)	0.38 (9.7)	0.38 (9.7)	0.12 (3.0)	11000 (757)	5500 (378)
1/8	1/16	-THN-MN2-MN1	1.01 (25.6)	0.44 (11.1)	0.38 (9.7)	0.38 (9.7)	0.12 (3.0)	11000 (757)	5500 (378)
1/8	1/8	-THN-MN2	1.01 (25.6)	0.44 (11.1)	0.38 (9.7)	0.38 (9.7)	0.19 (4.8)	10000 (689)	5000 (344)
1/4	1/16	-THN-MN4-MN1	1.22 (31.0)	0.56 (14.3)	0.56 (14.2)	0.38 (9.7)	0.12 (3.0)	11000 (757)	5500 (378)
1/4	1/8	-THN-MN4-MN2	1.22 (31.0)	0.56 (14.3)	0.56 (14.2)	0.38 (9.7)	0.19 (4.8)	10000 (689)	5000 (344)
1/4	1/4	-THN-MN4	1.40 (35.6)	0.56 (14.3)	0.56 (14.2)	0.56 (14.2)	0.28 (7.1)	8000 (551)	4000 (275)
3/8	1/16	-THN-MN6-MN1	1.25(31.8)	0.69 (17.5)	0.56 (14.2)	0.38 (9.7)	0.12 (3.0)	11000 (757)	5500 (378)
3/8	1/8	-THN-MN6-MN2	1.25 (31.8)	0.69 (17.5)	0.56 (14.2)	0.38 (9.7)	0.19 (4.8)	10000 (689)	5000 (344)
3/8	1/4	-THN-MN6-MN4	1.43 (36.3)	0.69 (17.5)	0.56 (14.2)	0.56 (14.2)	0.28 (7.1)	8000 (551)	4000 (275)
3/8	3/8	-THN-MN6	1.43 (36.3)	0.69 (17.5)	0.56 (14.2)	0.56 (14.2)	0.38 (9.7)	7800 (537)	3900 (268)
1/2	1/8	-THN-MN8-MN2	1.47 (37.3)	0.87 (22.2)	0.75 (19.1)	0.38 (9.7)	0.19 (4.8)	7700 (530)	3800 (261)
1/2	1/4	-THN-MN8-MN4	1.65 (41.9)	0.87 (22.2)	0.75 (19.1)	0.56 (14.2)	0.28 (7.1)	8000 (551)	4000 (275)
1/2	3/8	-THN-MN8-MN6	1.65 (41.9)	0.87 (22.2)	0.75 (19.1)	0.56 (14.2)	0.38 (9.7)	7800 (537)	3900 (268)
1/2	1/2	-THN-MN8	1.84 (46.7)	0.87 (22.2)	0.75 (19.1)	0.75 (19.1)	0.47 (11.9)	7700 (530)	3800 (261)
3/4	1/8	-THN-MN12-MN2	1.59 (40.4)	1.06 (27.0)	0.75 (19.1)	0.38 (9.7)	0.19 (4.8)	10000 (689)	5000 (344)
3/4	1/4	-THN-MN12-MN4	1.65 (41.9)	1.06 (27.0)	0.75 (19.1)	0.56 (14.2)	0.28 (7.1)	8000 (551)	4000 (275)
3/4	3/8	-THN-MN12-MN6	1.78 (45.2)	1.06 (27.0)	0.75 (19.1)	0.56 (14.2)	0.38 (9.7)	7800 (537)	3900 (268)
3/4	1/2	-THN-MN12-MN8	1.84 (46.7)	1.06 (27.0)	0.75 (19.1)	0.75 (19.1)	0.47 (11.9)	7700 (530)	3800 (261)
3/4	3/4	-THN-MN12	1.84 (46.7)	1.06 (27.0)	0.75 (19.1)	0.75 (19.1)	0.62 (15.7)	7300 (502)	3600 (248)
1	1/8	-THN-MN16-MN2	1.78 (45.2)	1.37 (34.9)	0.94 (23.9)	0.38 (9.7)	0.19 (4.8)	10000 (689)	5000 (344)
1	1/4	-THN-MN16-MN4	1.94 (49.3)	1.37 (34.9)	0.94 (23.9)	0.56 (14.2)	0.28 (7.1)	5300 (365)	2600 (179)
1	3/8	-THN-MN16-MN6	1.97 (50.0)	1.37 (34.9)	0.94 (23.9)	0.56 (14.2)	0.38 (9.7)	7800 (537)	3900 (268)
1	1/2	-THN-MN16-MN8	2.13 (54.1)	1.37 (34.9)	0.94 (23.9)	0.75 (19.1)	0.47 (11.9)	7700 (530)	3800 (261)
1	3/4	-THN-MN16-MN12	2.13 (54.1)	1.37 (34.9)	0.94 (23.9)	0.75 (19.1)	0.62 (15.7)	7300 (502)	3600 (248)
1	1	-THN-MN16	2.32 (58.9)	1.37 (34.9)	0.94 (23.9)	0.94 (23.9)	0.88 (22.4)	5300 (365)	2600 (179)
1 1/4	1	-THN-MN20-MN16	2.45 (62.2)	1.75 (44.5)	0.94 (23.9)	0.94 (23.9)	0.88 (22.4)	5300 (365)	2600 (179)
1 1/4	1 1/4	-THN-MN20	2.48 (62.9)	1.75 (44.5)	0.94 (23.9)	0.94 (23.9)	1.13 (28.6)	6000 (410)	3000 (200)
1 1/2	1 1/2	-THN-MN24	2.61 (66.3)	2.00 (50.8)	1.03 (26.2)	1.03 (26.2)	1.34 (34.0)	5000 (344)	2500 (172)
2	2	-THN-MN32	3.06 (77.7)	2.75 (69.9)	1.03 (26.2)	1.03 (26.2)	1.77 (45.0)	3900 (268)	1900 (130)

Heavy-Wall Male NPT Threads									
P-NPT Size	Px-NPT Size	Basic Ordering Number	Dimension,in(mm)					Working Pressure psig(bar)	
			L	F (Hex)	B	Bx	E	316SS, Steel	-
1/4	1/4	-THN-MN4-10K	1.40 (35.6)	0.56 (14.3)	0.56 (14.2)	0.56 (14.2)	0.23 (5.8)	10000 (689)	-
3/8	3/8	-THN-MN6-10K	1.43 (36.3)	0.69 (17.5)	0.56 (14.2)	0.56 (14.2)	0.28 (7.1)	10000 (689)	-
1/2	1/2	-THN-MN8-10K	1.84 (46.7)	0.87 (22.2)	0.75 (19.1)	0.75 (19.1)	0.39 (9.9)	10000 (689)	-
3/4	3/4	-THN-MN12-10K	1.84 (46.7)	1.06 (27.0)	0.75 (19.1)	0.75 (19.1)	0.47 (11.9)	10000 (689)	-
1	1	-THN-MN16-10K	2.32 (58.9)	1.37 (34.9)	0.94 (23.9)	0.94 (23.9)	0.62 (15.7)	10000 (689)	-

2 Pipe Fittings

Hex Nipples

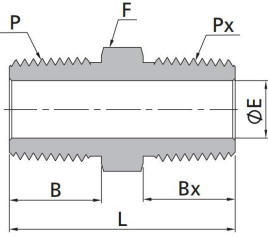

Male NPT Threads to Male ISO Tapered Threads

P-NPT Size	Px-RT Size	Basic Ordering Number	Dimension, in(mm)					Working Pressure psig(bar)	
			L	F (Hex)	B	Bx	E	316SS, Steel	Brass
1/8	1/8	-THN-MN2-RT2	1.01 (25.6)	0.44 (11.1)	0.38 (9.7)	0.38 (9.7)	0.19 (4.8)	10000 (689)	5000 (344)
1/4	1/4	-THN-MN4-RT4	1.40 (35.6)	0.56 (14.3)	0.56 (14.2)	0.56 (14.2)	0.28 (7.1)	8000 (551)	4000 (275)
3/8	3/8	-THN-MN6-RT6	1.43 (36.3)	0.69 (17.5)	0.56 (14.2)	0.56 (14.2)	0.38 (9.7)	7800 (537)	3900 (268)
1/2	1/2	-THN-MN8-RT8	1.84 (46.7)	0.87 (22.2)	0.75 (19.1)	0.75 (19.1)	0.47 (11.9)	7700 (530)	3800 (261)
3/4	3/4	-THN-MN12-RT12	1.84 (46.7)	1.06 (27.0)	0.75 (19.1)	0.75 (19.1)	0.62 (15.7)	7300 (502)	3600 (248)
1	1	-THN-MN16-RT16	2.32 (58.9)	1.37 (34.9)	0.94 (23.9)	0.94 (23.9)	0.88 (22.4)	5300 (365)	2600 (179)

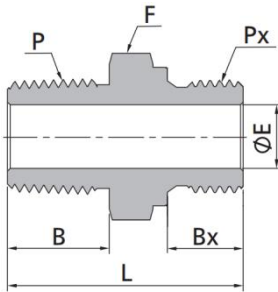

Male NPT Threads to Male ISO Parallel Threads

P-NPT Size	Px-Rs Size	Basic Ordering Number	Dimension, in(mm)					Working Pressure psig(bar)	
			L	F (Hex)	B	Bx	E	316SS, Steel	Brass
1/8	1/8	-THN-MN2-RS2	1.09 (27.7)	0.56 (14.3)	0.38 (9.7)	0.28 (7.1)	0.16 (4.1)	11400 (785)	5700 (392)
1/4	1/4	-THN-MN4-RS4	1.45 (36.8)	0.75 (19.1)	0.56 (14.2)	0.44 (11.2)	0.23 (5.8)	10300 (709)	5100 (351)
3/8	3/8	-THN-MN6-RS6	1.48 (37.6)	0.87 (22.2)	0.56 (14.2)	0.44 (11.2)	0.31 (7.9)	10300 (709)	5100 (351)
1/2	1/2	-THN-MN8-RS8	1.75 (44.4)	1.06 (27.0)	0.75 (19.1)	0.56 (14.2)	0.47 (11.9)	7600 (523)	3800 (261)
3/4	3/4	-THN-MN12-RS12	1.93 (49.0)	1.31 (33.3)	0.75 (19.1)	0.62 (15.7)	0.62 (15.7)	7300 (502)	3600 (248)
1	1	-THN-MN16-RS16	2.23 (56.6)	1.63 (41.3)	0.94 (23.9)	0.72 (18.3)	0.78 (19.8)	7400 (509)	3700 (254)

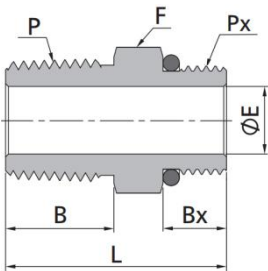

Male NPT Threads to Male ISO Parallel Threads

P-NPT Size	Px-SAE Size	Basic Ordering Number	Dimension, in(mm)					Working Pressure psig(bar)
			L	F (Hex)	B	Bx	E	316SS, Steel
1/4	7/16-20	-THN-MN4-S7	1.20 (30.5)	0.56 (14.3)	0.56 (14.2)	0.36 (9.1)	0.20 (5.1)	4500 (310)
3/8	9/16-18	-THN-MN6-S9	1.26 (32.0)	0.69 (17.5)	0.56 (14.2)	0.36 (9.1)	0.28 (7.1)	4500 (310)
1/2	3/4-16	-THN-MN8-S12	1.53 (38.9)	0.87 (22.2)	0.75 (19.1)	0.44 (11.2)	0.42 (10.7)	4500 (310)
3/4	1 1/16-12	-THN-MN12-S17	1.75 (44.4)	1.25 (31.8)	0.75 (19.1)	0.59 (15.0)	0.62 (15.7)	3600 (248)
1	1 5/16-12	-THN-MN16-S21	2.00 (50.8)	1.50 (38.1)	0.94 (23.9)	0.59 (15.0)	0.88 (22.4)	2900 (199)

3 Pipe Fittings

Hex Nipples

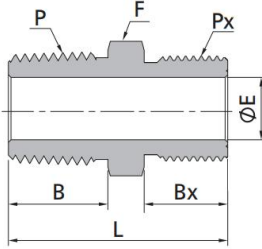

Male NPT Threads to Male Metric Threads

P-NPT Size	Px-Metric Size	Basic Ordering Number	Dimension, in(mm)					Working Pressure psig(bar)
			L	F (Hex)	B	Bx	E	
1/8	M20 x 1.5	-THN-MN2-M20	32.7 (1.29)	22.2 (0.87)	9.7 (0.38)	16.0 (0.63)	5.0 (0.20)	7700 (530)
1/4	M8 x 1	-THN-MN4-M8	29.0 (1.14)	14.3 (0.56)	14.2 (0.56)	9.0 (0.35)	3.2 (0.13)	8000 (551)
1/4	M14 x 1.5	-THN-MN4-M14	34.2 (1.35)	15.9 (0.63)	14.2 (0.56)	13.0 (0.51)	7.0 (0.28)	8000 (551)
1/4	M16 x 1.5	-THN-MN4-M16	35.2 (1.39)	17.5 (0.69)	14.2 (0.56)	14.0 (0.55)	7.1 (0.28)	7800 (537)
1/4	M20 x 1.5	-THN-MN4-M20	37.2 (1.46)	22.2 (0.87)	14.2 (0.56)	16.0 (0.63)	7.1 (0.28)	7700 (530)
3/8	M14 x 1.5	-THN-MN6-M14	34.2 (1.35)	17.5 (0.69)	14.2 (0.56)	13.0 (0.51)	7.0 (0.28)	7800 (537)
3/8	M20 x 1.5	-THN-MN6-M20	37.2 (1.46)	22.2 (0.87)	14.2 (0.56)	16.0 (0.63)	9.5 (0.37)	7700 (530)
3/8	M24 x 1.5	-THN-MN6-M24	38.2 (1.50)	25.4 (1.00)	14.2 (0.56)	17.0 (0.67)	9.5 (0.37)	7400 (509)
1/2	M14 x 1.5	-THN-MN8-M14	39.1 (1.54)	22.2 (0.87)	19.1 (0.75)	13.0 (0.51)	7.2 (0.28)	7700 (530)
1/2	M20 x 1.5	-THN-MN8-M20	42.0 (1.65)	22.2 (0.87)	19.1 (0.75)	16.0 (0.63)	10.0 (0.39)	7700 (530)
1/2	M24 x 1.5	-THN-MN8-M24	43.5 (1.71)	25.4 (1.00)	19.1 (0.75)	17.0 (0.67)	11.9 (0.47)	7400 (509)
3/4	M20 x 1.5	-THN-MN12-M20	42.1 (1.66)	27.0 (1.06)	19.1 (0.75)	16.0 (0.63)	10.8 (0.43)	7300 (502)
3/4	M27 x 2	-THN-MN12-M27	46.7 (1.84)	31.8 (1.25)	19.1 (0.75)	18.0 (0.71)	15.8 (0.62)	6100 (420)
1	M30 x 2	-THN-MN16-M30	56.3 (2.22)	34.9 (1.37)	23.9 (0.94)	20.0 (0.79)	19.4 (0.76)	6100 (420)

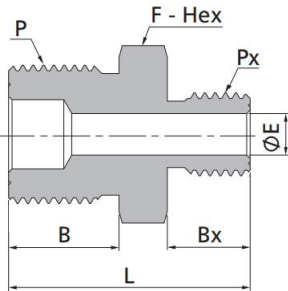

Male Metric Threads

P-Metric Size	Px-Metric Size	Basic Ordering Number	Dimension, in(mm)					Working Pressure psig(bar)
			L	F (Hex)	B	Bx	E	
M20 x 1.5	M10 x 1	-THN-M20-M10	34.0 (1.34)	22.0 (0.87)	16.0 (0.63)	11.0 (0.43)	4.0 (0.16)	10000 (689)
M20 x 1.5	M12 x 1.5	-THN-M20-M12	35.0 (1.38)	22.0 (0.87)	16.0 (0.63)	12.0 (0.47)	6.0 (0.24)	9000 (620)
M20 x 1.5	M14 x 1.5	-THN-M20-M14	36.0 (1.42)	22.0 (0.87)	16.0 (0.63)	13.0 (0.51)	7.2 (0.28)	8000 (551)
M20 x 1.5	M16 x 1.5	-THN-M20-M16	37.0 (1.46)	22.0 (0.87)	16.0 (0.63)	14.0 (0.55)	9.0 (0.35)	7800 (537)
M20 x 1.5	M20 x 1.5	-THN-M20	39.0 (1.54)	22.0 (0.87)	16.0 (0.63)	16.0 (0.63)	10.8 (0.43)	7700 (530)
M27 x 2	M27 x 2	-THN-M27	44.5 (1.75)	30.0 (1.18)	18.0 (0.71)	18.0 (0.71)	16.1 (0.63)	7300 (502)

4 Pipe Fittings

Hex Long Nipples

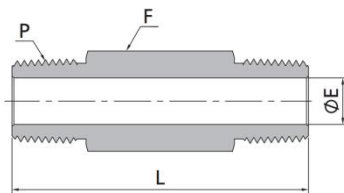

Male NPT Threads						
P-NPT Size	Basic Ordering Number	Dimension,in(mm)			Working Pressure psig(bar)	
		L	F (Hex)	E	316SS, Steel	/
1/8	-THL-MN2-1.5	1.50 (38.1)	0.44 (11.1)	0.19 (4.8)	10000 (689)	5000 (344)
1/8	-THL-MN2-2	2.00 (50.8)	0.44 (11.1)	0.19 (4.8)	10000 (689)	5000 (344)
1/8	-THL-MN2-2.5	2.50 (63.5)	0.44 (11.1)	0.19 (4.8)	10000 (689)	5000 (344)
1/8	-THL-MN2-3	3.00 (76.2)	0.44 (11.1)	0.19 (4.8)	10000 (689)	5000 (344)
1/4	-THL-MN4-1.5	1.50 (38.1)	0.56 (14.3)	0.28 (7.1)	8000 (551)	4000 (275)
1/4	-THL-MN4-2	2.00 (50.8)	0.56 (14.3)	0.28 (7.1)	8000 (551)	4000 (275)
1/4	-THL-MN4-2.5	2.50 (63.5)	0.56 (14.3)	0.28 (7.1)	8000 (551)	4000 (275)
1/4	-THL-MN4-3	3.00 (76.2)	0.56 (14.3)	0.28 (7.1)	8000 (551)	4000 (275)
1/4	-THL-MN4-4	4.00 (101.6)	0.56 (14.3)	0.28 (7.1)	8000 (551)	4000 (275)
3/8	-THL-MN6-1.5	1.50 (38.1)	0.69 (17.5)	0.38 (9.7)	7800 (537)	3900 (268)
3/8	-THL-MN6-2	2.00 (50.8)	0.69 (17.5)	0.38 (9.7)	7800 (537)	3900 (268)
3/8	-THL-MN6-2.5	2.50 (63.5)	0.69 (17.5)	0.38 (9.7)	7800 (537)	3900 (268)
3/8	-THL-MN6-3	3.00 (76.2)	0.69 (17.5)	0.38 (9.7)	7800 (537)	3900 (268)
3/8	-THL-MN6-4	4.00 (101.6)	0.69 (17.5)	0.38 (9.7)	7800 (537)	3900 (268)
1/2	-THL-MN8-2	2.00 (50.8)	0.87 (22.2)	0.47 (11.9)	7700 (530)	3800 (261)
1/2	-THL-MN8-3	3.00 (76.2)	0.87 (22.2)	0.47 (11.9)	7700 (530)	3800 (261)
1/2	-THL-MN8-4	4.00 (101.6)	0.87 (22.2)	0.47 (11.9)	7700 (530)	3800 (261)
1/2	-THL-MN8-6	6.00 (152.4)	0.87 (22.2)	0.47 (11.9)	7700 (530)	3800 (261)
3/4	-THL-MN12-2	2.00 (50.8)	1.06 (27.0)	0.62 (15.7)	7300 (502)	3600 (248)
3/4	-THL-MN12-3	3.00 (76.2)	1.06 (27.0)	0.62 (15.7)	7300 (502)	3600 (248)
3/4	-THL-MN12-4	4.00 (101.6)	1.06 (27.0)	0.62 (15.7)	7300 (502)	3600 (248)
1	-THL-MN16-3	3.00 (76.2)	1.37 (34.9)	0.88 (22.4)	5300 (365)	2600 (179)
1	-THL-MN16-4	4.00 (101.6)	1.37 (34.9)	0.88 (22.4)	5300 (365)	2600 (179)

Male Tapered Threads						
P-RT Size	Basic Ordering Number	Dimension,in(mm)			Working Pressure psig(bar)	
		L	F (Hex)	E	316SS, Steel	Brass
1/8	-THL-RT2- 2	2.00 (50.8)	0.44 (11.1)	0.19 (4.8)	10000 (689)	5000 (344)
1/8	-THL-RT2-2.5	2.50 (63.5)	0.44 (11.1)	0.19 (4.8)	10000 (689)	5000 (344)
1/8	-THL-RT2-3	3.00 (76.2)	0.44 (11.1)	0.19 (4.8)	10000 (689)	5000 (344)
1/4	-THL-RT4-2	2.00 (50.8)	0.56 (14.3)	0.28 (7.1)	8000 (551)	4000 (275)
1/4	-THL-RT4-2.5	2.50 (63.5)	0.56 (14.3)	0.28 (7.1)	8000 (551)	4000 (275)
1/4	-THL-RT4-3	3.00 (76.2)	0.56 (14.3)	0.28 (7.1)	8000 (551)	4000 (275)
1/4	-THL-RT4-4	4.00 (101.6)	0.56 (14.3)	0.28 (7.1)	8000 (551)	4000 (275)
3/8	-THL-RT6-2	2.00 (50.8)	0.69 (17.5)	0.38 (9.7)	7800 (537)	3900 (268)
3/8	-THL-RT6-2.5	2.50 (63.5)	0.69 (17.5)	0.38 (9.7)	7800 (537)	3900 (268)
3/8	-THL-RT6-3	3.00 (76.2)	0.69 (17.5)	0.38 (9.7)	7800 (537)	3900 (268)
3/8	-THL-RT6-4	4.00 (101.6)	0.69 (17.5)	0.38 (9.7)	7800 (537)	3900 (268)
1/2	-THL-RT8-2	2.00 (50.8)	0.87 (22.2)	0.47 (11.9)	7700 (530)	3800 (261)
1/2	-THL-RT8-3	3.00 (76.2)	0.87 (22.2)	0.47 (11.9)	7700 (530)	3800 (261)
1/2	-THL-RT8-4	4.00 (101.6)	0.87 (22.2)	0.47 (11.9)	7700 (530)	3800 (261)
1/2	-THL-RT8-6	6.00 (152.4)	0.87 (22.2)	0.47 (11.9)	7700 (530)	3800 (261)
3/4	-THL-RT12-2	2.00 (50.8)	1.06 (27.0)	0.62 (15.7)	7300 (502)	3600 (248)
3/4	-THL-RT12-3	3.00 (76.2)	1.06 (27.0)	0.62 (15.7)	7300 (502)	3600 (248)
3/4	-THL-RT12-4	4.00 (101.6)	1.06 (27.0)	0.62 (15.7)	7300 (502)	3600 (248)
1	-THL-RT16-3	3.00 (76.2)	1.37 (34.9)	0.88 (22.4)	5300 (365)	2600 (179)
1	-THL-RT16-4	4.00 (101.6)	1.37 (34.9)	0.88 (22.4)	5300 (365)	2600 (179)

5 Pipe Fittings

Close Nipples

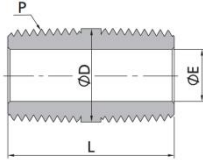

Male NPT Threads						
P-NPT Size	Basic Ordering Number	Dimension,in(mm)			Working Pressure psig(bar)	
		L	D	E	316SS, Steel	Brass
1/16	-TCN-MN1	0.75 (19.1)	0.31 (7.9)	0.12 (3.0)	11000(757)	5500(378)
1/8	-TCN-MN2	0.75 (19.1)	0.41 (10.3)	0.19 (4.8)	10000(689)	5000(344)
1/4	-TCN-MN4	1.12 (28.4)	0.54 (13.7)	0.28 (7.1)	8000(551)	4000(275)
3/8	-TCN-MN6	1.12 (28.4)	0.67 (17.1)	0.38 (9.6)	7800(537)	3900(268)
1/2	-TCN-MN8	1.50 (38.1)	0.84 (21.3)	0.47 (11.9)	7700(530)	3800(261)
3/4	-TCN-MN12	1.50 (38.1)	1.05 (26.7)	0.62 (15.7)	7300(502)	3600(248)
1	-TCN-MN16	1.88 (47.8)	1.31 (33.4)	0.88 (22.4)	5300(365)	2600(179)

Male ISO Threads						
P-RT Size	Basic Ordering Number	Dimension,in(mm)			Working Pressure psig(bar)	
		L	D	E	316SS, Steel	Brass
1/16	-TCN-RT1	0.75 (19.1)	0.31 (7.9)	0.12 (3.0)	11000(757)	5500(378)
1/8	-TCN-RT2	0.75 (19.1)	0.41 (10.3)	0.19 (4.8)	10000(689)	5000(344)
1/4	-TCN-RT4	1.12 (28.4)	0.54 (13.7)	0.28 (7.1)	8000(551)	4000(275)
3/8	-TCN-RT6	1.12 (28.4)	0.67 (17.1)	0.38 (9.7)	7800(537)	3900(268)
1/2	-TCN-RT8	1.50 (38.1)	0.84 (21.3)	0.47 (11.9)	7700(530)	3800(261)
3/4	-TCN-RT12	1.50 (38.1)	1.05 (26.7)	0.62 (15.7)	7300(502)	3600(248)
1	-TCN-RT16	1.88 (47.8)	1.31 (33.4)	0.88 (22.4)	5300(365)	2600(179)

Special Pipe Nipples

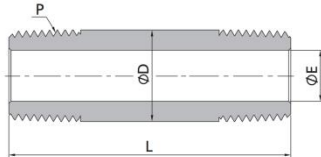

Male NPT Threads						
P-NPT Size	Basic Ordering Number	Dimension,in(mm)			Working Pressure psig(bar)	
		L	D	E	316SS, Steel	Brass
1/8	-TSN-MN2-1.5	1.50 (38.1)	0.41 (10.3)	0.19 (4.8)	10000(689)	5000(344)
1/8	-TSN-MN2-2	2.00(50.8)	0.41 (10.3)	0.19 (4.8)	10000(689)	5000(344)
1/8	-TSN-MN2-2.5	2.50(63.5)	0.41 (10.3)	0.19 (4.8)	10000(689)	5000(344)
1/8	-TSN-MN2-3	3.00(76.2)	0.41 (10.3)	0.19 (4.8)	10000(689)	5000(344)
1/4	-TSN-MN4-1.5	1.50 (38.1)	0.54 (13.7)	0.28 (7.1)	8000(551)	4000(275)
1/4	-TSN-MN4-2	2.00(50.8)	0.54 (13.7)	0.28 (7.1)	8000(551)	4000(275)
1/4	-TSN-MN4-2.5	2.50(63.5)	0.54 (13.7)	0.28 (7.1)	8000(551)	4000(275)
1/4	-TSN-MN4-3	3.00(76.2)	0.54 (13.7)	0.28 (7.1)	8000(551)	4000(275)
1/4	-TSN-MN4-4	4.00(101.6)	0.54 (13.7)	0.28 (7.1)	8000(551)	4000(275)
3/8	-TSN-MN6-1.5	1.50 (38.1)	0.67 (17.1)	0.38(9.7)	7800(537)	3900(268)
3/8	-TSN-MN6-2	2.00(50.8)	0.67 (17.1)	0.38(9.7)	7800(537)	3900(268)
3/8	-TSN-MN6-2.5	2.50(63.5)	0.67 (17.1)	0.38(9.7)	7800(537)	3900(268)
3/8	-TSN-MN6-3	3.00(76.2)	0.67 (17.1)	0.38(9.7)	7800(537)	3900(268)
3/8	-TSN-MN6-4	4.00(101.6)	0.67 (17.1)	0.38(9.7)	7800(537)	3900(268)
1/2	-TSN-MN8-2	2.00(50.8)	0.84 (21.3)	0.47 (11.9)	7700(530)	3800(261)
1/2	-TSN-MN8-3	3.00(76.2)	0.84 (21.3)	0.47 (11.9)	7700(530)	3800(261)
1/2	-TSN-MN8-4	4.00(101.6)	0.84 (21.3)	0.47 (11.9)	7700(530)	3800(261)
1/2	-TSN-MN8-6	6.00(152.4)	0.84 (21.3)	0.47 (11.9)	7700(530)	3800(261)
3/4	-TSN-MN12-2	2.00(50.8)	1.05 (26.7)	0.62 (15.7)	7300(502)	3600(248)
3/4	-TSN-MN12-3	3.00(76.2)	1.05 (26.7)	0.62 (15.7)	7300(502)	3600(248)
3/4	-TSN-MN12-4	4.00(101.6)	1.05 (26.7)	0.62 (15.7)	7300(502)	3600(248)
1	-TSN-MN16-3	3.00(76.2)	1.31 (33.4)	0.88 (22.4)	5300(365)	2600(179)
1	-TSN-MN16-4	4.00(101.6)	1.31 (33.4)	0.88 (22.4)	5300(365)	2600(179)

6 Pipe Fittings

Adapters

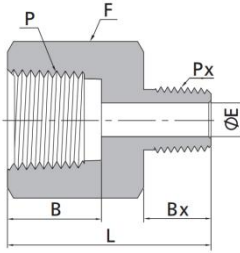

Female to Male NPT Threads									
P-NPT Size	Px-NPT Size	Basic Ordering Number	Dimension, in(mm)					Working Pressure psig(bar)	
			L	F (Hex)	B	Bx	E	316SS, Steel	Brass
1/8	1/16	-TAD-FN2-MN1	1.09 (27.7)	0.56 (14.3)	0.41(10.4)	0.38(9.7)	0.12(3.0)	6500 (447)	3200(220)
1/8	1/8	-TAD-FN2-MN2	1.10 (27.9)	0.56 (14.3)	0.41(10.4)	0.38(9.7)	0.19(4.8)	6500 (447)	3200(220)
1/4	1/16	-TAD-FN4-MN1	1.20 (30.5)	0.75 (19.1)	0.59 (15.0)	0.38(9.7)	0.12(3.0)	6600 (454)	3300 (227)
1/4	1/8	-TAD-FN4-MN2	1.26 (32.0)	0.75 (19.1)	0.59 (15.0)	0.38(9.7)	0.19(4.8)	6600 (454)	3300 (227)
1/4	1/4	-TAD-FN4-MN4	1.40 (35.6)	0.75 (19.1)	0.59 (15.0)	0.56 (14.2)	0.28 (7.1)	6600 (454)	3300 (227)
3/8	1/16	-TAD-FN6-MN1	1.25 (31.8)	0.87 (22.2)	0.59 (15.0)	0.38 (9.7)	0.12 (3.0)	5300 (365)	2600 (179)
3/8	1/8	-TAD-FN6-MN2	1.33 (33.8)	0.87 (22.2)	0.59 (15.0)	0.38 (9.7)	0.19 (4.8)	5300 (365)	2600 (179)
3/8	1/4	-TAD-FN6-MN4	1.50 (38.1)	0.87 (22.2)	0.59 (15.0)	0.56 (14.2)	0.28 (7.1)	5300 (365)	2600 (179)
3/8	3/8	-TAD-FN6-MN6	1.51 (38.4)	0.87 (22.2)	0.59 (15.0)	0.56 (14.2)	0.38 (9.6)	5300 (365)	2600 (179)
1/2	1/8	-TAD-FN8-MN2	1.58 (40.1)	1.06 (27.0)	0.78 (19.8)	0.38 (9.7)	0.19 (4.8)	4900 (337)	2400 (165)
1/2	1/4	-TAD-FN8-MN4	1.76 (44.7)	1.06 (27.0)	0.78 (19.8)	0.56 (14.2)	0.28 (7.1)	4900 (337)	2400 (165)
1/2	3/8	-TAD-FN8-MN6	1.75 (44.4)	1.06 (27.0)	0.78 (19.8)	0.56 (14.2)	0.38 (9.6)	4900 (337)	2400 (165)
1/2	1/2	-TAD-FN8-MN8	1.94 (49.3)	1.06 (27.0)	0.78 (19.8)	0.75 (19.1)	0.47 (11.9)	4900 (337)	2400 (165)
3/4	1/8	-TAD-FN12-MN2	1.56 (39.6)	1.31 (33.3)	0.81 (20.6)	0.38 (9.7)	0.19 (4.8)	4600 (316)	2300 (158)
3/4	1/4	-TAD-FN12-MN4	1.85 (47.0)	1.31 (33.3)	0.81 (20.6)	0.56 (14.2)	0.28 (7.1)	4600 (316)	2300 (158)
3/4	3/8	-TAD-FN12-MN6	1.82 (46.2)	1.31 (33.3)	0.81 (20.6)	0.56 (14.2)	0.38 (9.6)	4600 (316)	2300 (158)
3/4	1/2	-TAD-FN12-MN8	2.02 (51.3)	1.31 (33.3)	0.81 (20.6)	0.75 (19.1)	0.47 (11.9)	4600 (316)	2300 (158)
3/4	3/4	-TAD-FN12-MN12	2.02 (51.3)	1.31 (33.3)	0.81 (20.6)	0.75 (19.1)	0.62 (15.7)	4600 (316)	2300 (158)
1	1/8	-TAD-FN16-MN2	1.81 (46.0)	1.63 (41.3)	1.00 (25.4)	0.38 (9.7)	0.19 (4.8)	4400 (303)	2200 (151)
1	1/4	-TAD-FN16-MN4	1.96 (49.8)	1.63 (41.3)	1.00 (25.4)	0.56 (14.2)	0.28 (7.1)	4400 (303)	2200 (151)
1	3/8	-TAD-FN16-MN6	2.00 (50.8)	1.63 (41.3)	1.00 (25.4)	0.56 (14.2)	0.38 (9.6)	4400 (303)	2200 (151)
1	1/2	-TAD-FN16-MN8	2.16 (54.9)	1.63 (41.3)	1.00 (25.4)	0.75 (19.1)	0.47 (11.9)	4400 (303)	2200 (151)
1	3/4	-TAD-FN16-MN12	2.17 (55.1)	1.63 (41.3)	1.00 (25.4)	0.75 (19.1)	0.62 (15.7)	4400 (303)	2200 (151)
1	1	-TAD-FN16-MN16	2.28 (57.9)	1.63 (41.3)	1.00 (25.4)	0.94 (23.9)	0.88 (22.4)	4400 (303)	2200 (151)
1 1/4	1	-TAD-FN20-MN16	2.47 (62.7)	2.13 (54.0)	1.00 (25.4)	0.94 (23.9)	0.88 (22.4)	5000 (344)	2500 (172)
Heavy-Wall Female to Male NPT Threads									
1/4	1/4	-TAD-FN4-MN4-10K	1.43 (36.3)	1.00 (25.4)	0.59 (15.0)	0.56 (14.2)	0.23 (5.8)	10000 (689)	/
1/2	1/2	-TAD-FN8-MN8-10K	2.02 (51.3)	1.50 (38.1)	0.78 (19.8)	0.75 (19.1)	0.39 (9.9)	10000 (689)	/
1/2	1/4	-TAD-FN8-MN4-10K	1.81 (46.0)	1.50 (38.1)	0.78 (19.8)	0.56 (14.2)	0.23 (5.8)	10000 (689)	/

Female NPT Threads to Male ISO Parallel Threads									
P-NPT Size	Px-RT Size	Basic Ordering Number	Dimension, in(mm)					Working Pressure psig(bar)	
			L	F (Hex)	B	Bx	E	316SS, Steel	Brass
1/8	1/8	-TAD-FN2-RT2	1.09 (27.7)	0.56 (14.3)	0.41 (10.4)	0.38 (9.7)	0.19 (4.8)	6500 (447)	3200 (220)
1/4	1/4	-TAD-FN4-RT4	1.42 (36.1)	0.75 (19.1)	0.59 (15.0)	0.56 (14.2)	0.28 (7.1)	6600 (454)	3300 (227)
3/8	3/8	-TAD-FN6-RT6	1.50 (38.1)	0.87 (22.2)	0.59 (15.0)	0.56 (14.2)	0.38 (9.6)	5300 (365)	2600 (179)
1/2	1/2	-TAD-FN8-RT8	1.94 (49.3)	1.06 (27.0)	0.78 (19.8)	0.75 (19.1)	0.47 (11.9)	4900 (337)	2400 (165)
3/4	3/4	-TAD-FN12-RT12	2.02 (51.3)	1.31 (33.3)	0.81 (20.6)	0.75 (19.1)	0.62 (15.7)	4600 (316)	2300 (158)
1	1	-TAD-FN16-RT16	2.30(58.4)	1.63 (41.3)	1.00 (25.4)	0.94 (23.9)	0.88 (22.4)	4400 (303)	2200 (151)

Adapters

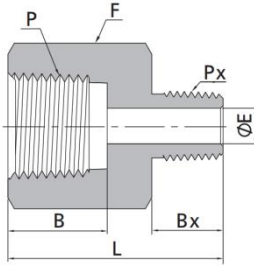

Female NPT Threads to Male ISO Tapered Threads									
P-NPT Size	Px-RX Size	Basic Ordering Number	Dimension,in(mm)					Working Pressure psig(bar)	
			L	F (Hex)	B	Bx	E	316SS, Steel	Brass
1/8	1/8	-TAD-FR2-MR2	1.09 (27.7)	0.56 (14.3)	0.41 (10.4)	0.38 (9.7)	0.19 (4.8)	6500 (447)	3200 (220)
1/4	1/8	-TAD-FR4-MR2	1.26(32.0)	0.75 (19.1)	0.59 (15.0)	0.38 (9.7)	0.19 (4.8)	6600 (454)	3300 (227)
1/4	1/4	-TAD-FR4-MR4	1.42 (36.1)	0.75 (19.1)	0.59 (15.0)	0.56 (14.2)	0.28 (7.1)	6600 (454)	3300 (227)
3/8	1/4	-TAD-FR6-MR4	1.50 (38.1)	0.87 (22.2)	0.59 (15.0)	0.56 (14.2)	0.28 (7.1)	5300 (365)	2600 (179)
3/8	3/8	-TAD-FR6-MR6	1.50 (38.1)	0.87 (22.2)	0.59 (15.0)	0.56 (14.2)	0.38 (9.7)	5300 (365)	2600 (179)
1/2	1/4	-TAD-FR8-MR4	1.76 (44.7)	1.06 (27.0)	0.78 (19.8)	0.56 (14.2)	0.28 (7.1)	4900 (337)	2400 (165)
1/2	3/8	-TAD-FR8-MR6	1.75 (44.4)	1.06 (27.0)	0.78 (19.8)	0.56 (14.2)	0.38 (9.7)	4900 (337)	2400 (165)
1/2	1/2	-TAD-FR8-MR8	1.95(49.5)	1.06 (27.0)	0.78 (19.8)	0.75 (19.1)	0.47 (11.9)	4900 (337)	2400 (165)
3/4	3/4	-TAD-FR12-MR12	2.02 (51.3)	1.31 (33.3)	0.81 (20.6)	0.75 (19.1)	0.62 (15.7)	4600 (316)	2300 (158)
1	1	-TAD-FR16-MR16	2.30(58.4)	1.63 (41.3)	1.00 (25.4)	0.94 (23.9)	0.88 (22.4)	4400 (303)	2200 (151)

Female ISO Tapered Threads to Male NPT Threads									
P-RT Size	Px-NPT Size	Basic Ordering Number	Dimension,in(mm)					Working Pressure psig(bar)	
			L	F (Hex)	B	Bx	E	316SS, Steel	Brass
1/8	1/8	-TAD-FR2-MN2	1.09 (27.7)	0.56 (14.3)	0.41 (10.4)	0.38 (9.7)	0.19 (4.8)	6500 (447)	3200 (220)
1/4	1/4	-TAD-FR4-MN4	1.43 (36.3)	0.75 (19.1)	0.59 (15.0)	0.56 (14.2)	0.28 (7.1)	6600 (454)	3300 (227)
3/8	3/8	-TAD-FR6-MN6	1.51 (38.4)	0.87 (22.2)	0.59 (15.0)	0.56 (14.2)	0.38 (9.6)	5300 (365)	2600 (179)
1/2	1/2	-TAD-FR8-MN8	1.96 (49.8)	1.06 (27.0)	0.78 (19.8)	0.75 (19.1)	0.47 (11.9)	4900 (337)	2400 (165)
3/4	3/4	-TAD-FR12-MN12	2.02 (51.3)	1.31 (33.3)	0.81 (20.6)	0.75 (19.1)	0.62 (15.7)	4600 (316)	2300 (158)
1	1	-TAD-FR16-MN16	2.30 (58.4)	1.63 (41.3)	1.00 (25.4)	0.94 (23.9)	0.88 (22.4)	4400 (303)	2200 (151)

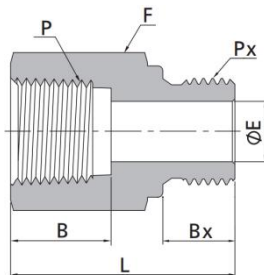

Size	Size	Number	Dimension,in(mm)					Working Pressure psig(bar)	
			L	F (Hex)	B	Bx	E	316SS, Steel	Brass
1/8	1/8	-TAD-FN2-RS2	0.99 (25.1)	0.56 (14.3)	0.39 (9.9)	0.28 (7.1)	0.16 (4.1)	6500 (447)	3200 (220)
1/4	1/4	-TAD-FN4-RS4	1.32 (33.5)	0.75 (19.1)	0.41 (10.4)	0.44 (11.2)	0.23 (5.8)	6600 (454)	3300 (227)
3/8	3/8	-TAD-FN6-RS6	1.41 (35.8)	0.87 (22.2)	0.59 (15.0)	0.44 (11.2)	0.31 (7.9)	5300 (365)	2600 (179)
1/2	1/2	-TAD-FN8-RS8	1.74 (44.2)	1.06 (27.0)	0.81 (20.6)	0.56 (14.2)	0.47 (11.9)	4900 (337)	2400 (165)
3/4	3/4	-TAD-FN12-RS12	1.89 (48.0)	1.31 (33.3)	0.81 (20.6)	0.62 (15.7)	0.62 (15.7)	4600 (316)	2300 (158)

Adapters

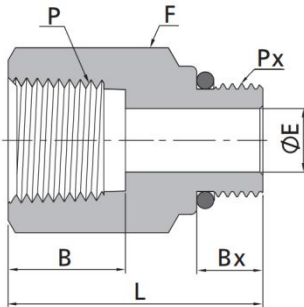

Female NPT Threads to Male SAE/MS Threads								
P-NPT Size	Px-RX Size	Basic Ordering Number	Dimension, in(mm)					Working Pressure
			L	F (Hex)	B	Bx	E	316SS, Steel
1/4	7/16-20	-TAD-FN4-S7	1.32 (33.5)	0.75 (19.1)	0.59 (15.0)	0.36 (9.1)	0.20 (5.1)	4500(310)
3/8	9/16-18	-TAD-FN6-S9	1.39 (35.3)	0.94 (23.8)	0.59 (15.0)	0.39 (9.9)	0.28 (7.1)	4500(310)
1/2	3/4-16	-TAD-FN8-S12	1.76 (44.7)	1.06 (27.0)	0.78 (19.8)	0.44 (11.2)	0.42 (10.7)	4500(310)
3/4	1 1/16-12	-TAD-FN12-S17	1.99 (50.5)	1.37 (34.9)	0.81 (20.6)	0.59 (15.0)	0.66 (16.8)	3600(248)
1	1 5/16-12	-TAD-FN16-S21	2.12 (53.8)	1.63 (41.3)	1.00 (25.4)	0.59 (15.0)	0.85 (21.5)	2900(199)

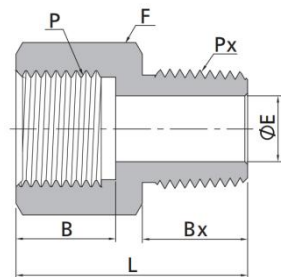

Female ISO Parallel Threads to Male NPT Threads								
P-RG Size	Px-NPT Size	Basic Ordering Number	Dimension, in(mm)					Working Pressure
			L	F (Hex)	B	Bx	E	316SS, Steel
1/8	1/8	-TAD-RG2-MN2	0.86 (21.8)	0.56 (14.3)	0.26 (6.5)	0.38 (9.7)	0.18 (4.5)	6100(420)
1/4	1/4	-TAD-RG4-MN4	1.19 (30.2)	0.75 (19.1)	0.51 (12.9)	0.56 (14.2)	0.22 (5.5)	5700(392)
3/8	3/8	-TAD-RG6-MN6	1.27 (32.2)	0.94 (23.8)	0.56 (14.2)	0.56 (14.2)	0.26 (6.5)	5700(392)
1/2	1/2	-TAD-RG8-MN8	1.68 (42.7)	1.06 (27.0)	0.74 (18.8)	0.75 (19.1)	0.28 (7.0)	3900(268)
3/4	3/4	-TAD-RG12-MN12	2.02 (51.3)	1.31 (33.3)	0.81 (20.6)	0.75 (19.1)	0.62 (15.7)	4600 (316)
1	1	-TAD-RG16M-N16	2.30(58.4)	1.63 (41.3)	1.00 (25.4)	0.94 (23.9)	0.88 (22.4)	4400 (303)

Reducing Bushings

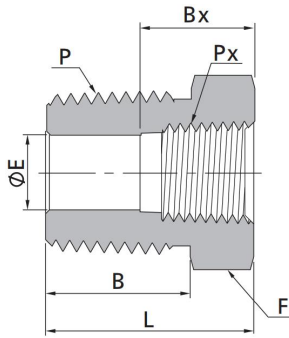

Male NPT to Female NPT Threads									
P-NPT Size	Px-NPT Size	Basic Ordering Number	Dimension, in(mm)					Working Pressure psig(bar)	
			L	F (Hex)	B	Bx	E	316SS, Steel	Brass
1/8	1/16	-TRB-MN2-FN1	1.03 (26.2)	0.44 (11.1)	0.38 (9.7)	0.39 (9.9)	0.19 (4.8)	6500 (447)	3200 (220)
1/4	1/16	-TRB-MN4-FN1	0.86 (21.8)	0.56 (14.3)	0.56 (14.2)	0.39 (9.9)	0.19 (4.8)	8000 (551)	4000 (275)
1/4	1/8	-TRB-MN4-FN2	1.06 (26.9)	0.56 (14.3)	0.56 (14.2)	0.41 (10.4)	0.28 (7.1)	6500 (447)	3300 (227)
3/8	1/16	-TRB-MN6-FN1	0.86 (21.8)	0.69 (17.5)	0.56 (14.2)	0.39 (9.9)	0.19 (4.8)	13300 (971)	6600 (454)
3/8	1/8	-TRB-MN6-FN2	0.86 (21.8)	0.69 (17.5)	0.56 (14.2)	0.41 (10.4)	0.34 (8.6)	9200 (633)	4700 (323)
3/8	1/4	-TRB-MN6-FN4	1.19 (30.2)	0.75 (19.1)	0.56 (14.2)	0.59 (15.0)	0.38 (9.6)	6600 (454)	3300 (227)
1/2	1/8	-TRB-MN8-FN2	1.08 (27.4)	0.87 (22.2)	0.75 (19.1)	0.41 (10.4)	0.34 (8.6)	12200 (840)	6200 (427)
1/2	1/4	-TRB-MN8-FN4	1.08 (27.4)	0.87 (22.2)	0.75 (19.1)	0.59 (15.0)	0.45 (11.4)	8300 (571)	4400 (303)
1/2	3/8	-TRB-MN8-FN6	1.41 (35.8)	0.87 (22.2)	0.75 (19.1)	0.59 (15.0)	0.47 (11.9)	5300 (365)	2600 (179)
3/4	1/8	-TRB-MN12-FN2	1.08 (27.4)	1.06 (27.0)	0.75 (19.1)	0.41 (10.4)	0.28 (7.1)	20000(1378)	10000(689)
3/4	1/4	-TRB-MN12-FN4	1.08 (27.4)	1.06 (27.0)	0.75 (19.1)	0.59 (15.0)	0.45 (11.4)	12000 (826)	6000 (410)
3/4	3/8	-TRB-MN12-FN6	1.08 (27.4)	1.06 (27.0)	0.75 (19.1)	0.59 (15.0)	0.59 (15.0)	8200 (564)	4300 (296)
3/4	1/2	-TRB-MN12-FN8	1.63 (41.4)	1.06 (27.0)	0.75 (19.1)	0.78 (19.8)	0.62 (15.7)	4900 (337)	2400 (165)
1	1/8	-TRB-MN16-FN2	1.36 (34.5)	1.37 (34.9)	0.94 (23.9)	0.41 (10.4)	0.28 (7.1)	20000(1378)	10000(689)
1	1/4	-TRB-MN16-FN4	1.37 (34.8)	1.37 (34.9)	0.94 (23.9)	0.59 (15.0)	0.45 (11.4)	14500 (999)	7400 (509)
1	3/8	-TRB-MN16-FN6	1.37 (34.8)	1.37 (34.9)	0.94 (23.9)	0.59 (15.0)	0.59 (15.0)	11600 (799)	5900 (406)
1	1/2	-TRB-MN16-FN8	1.37 (34.8)	1.37 (34.9)	0.94 (23.9)	0.78 (19.8)	0.73 (18.5)	8600 (592)	4300 (296)
1	3/4	-TRB-MN16-FN12	1.85 (47.0)	1.37 (34.9)	0.94 (23.9)	0.81 (20.6)	0.88 (22.4)	5300 (365)	2600 (179)
1 1/4	3/4	-TRB-MN20-FN12	1.47 (37.3)	1.75 (44.5)	0.94 (23.9)	0.81 (20.6)	0.88 (22.4)	7800 (537)	3900 (268)
1 1/4	1	-TRB-MN20-FN16	1.47 (37.3)	1.75 (44.5)	0.94 (23.9)	1.00 (25.4)	0.88 (22.4)	3500 (241)	1750 (120)
1 1/2	1	-TRB-MN24-FN16	1.58 (40.1)	2.00 (50.8)	1.03 (26.2)	1.00 (25.4)	0.88 (22.4)	6600 (454)	3300 (227)
1 1/2	1 1/4	-TRB-MN24-FN20	2.20 (56.0)	2.13 (54.0)	1.03 (26.2)	1.00 (25.4)	1.34 (34.0)	5000 (344)	2500 (172)

Male ISO Tapered Threads to Female ISO Tapered Threads									
P-RT Size	Px-RT Size	Basic Ordering Number	Dimension, in(mm)					Working Pressure psig(bar)	
			L	F (Hex)	B	Bx	E	316SS, Steel	Brass
1/4	1/8	-TRB-MR4-FR2	1.06 (26.9)	0.56 (14.3)	0.56 (14.2)	0.41 (10.4)	0.28 (7.1)	6500 (447)	3200(220)
3/8	1/4	-TRB-MR6-FR4	1.19 (30.2)	0.75 (19.1)	0.56 (14.2)	0.59 (15.0)	0.38 (9.6)	6600 (454)	3300(227)
1/2	1/4	-TRB-MR8-FR4	1.08 (27.4)	0.87 (22.2)	0.75 (19.1)	0.59 (15.0)	0.44 (11.2)	8300 (571)	4400(303)
1/2	3/8	-TRB-MR8-FR6	1.41 (35.8)	0.87 (22.2)	0.75 (19.1)	0.59 (15.0)	0.47 (11.9)	5300 (365)	2600(179)
3/4	1/2	-TRB-MR12-FR8	1.63 (41.4)	1.06 (27.0)	0.75 (19.1)	0.78 (19.8)	0.62 (15.7)	4900 (337)	2400 (165)
1	3/4	-TRB-MR16-FR12	1.85 (47.0)	1.37 (34.9)	0.94 (23.9)	0.81 (20.6)	0.88 (22.4)	5300 (365)	2600 (179)
1 1/4	1	-TRB-MR20-FR16	1.47 (37.3)	1.75 (44.5)	0.94 (23.9)	1.00 (25.4)	0.88 (22.4)	3500 (241)	1750 (120)
1 1/2	1	-TRB-MR24-FR16	1.58 (40.1)	2.00 (50.8)	1.03 (26.2)	1.00 (25.4)	0.88 (22.4)	6600 (454)	3300 (227)
1 1/2	1 1/4	-TRB-MR24-FR20	2.20 (56.0)	2.13 (54.0)	1.03 (26.2)	1.00 (25.4)	1.34 (34.0)	5000 (344)	2500 (172)

Hex Couplings

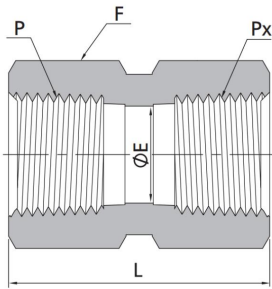

Female NPT Threads							
P-NPT Size	Px-NPT Size	Basic Ordering Number	Dimension, in(mm)			Working Pressure psig(bar)	
			L	F (Hex)	E	316SS, Steel	Brass
1/16	1/16	-THC-FN1	0.78(19.8)	0.44(11.1)	0.19(4.8)	6700 (460)	3300 (227)
1/8	1/8	-THC-FN2	0.81(20.6)	0.56 (14.3)	0.34(8.6)	6500 (447)	3200 (220)
1/4	1/8	-THC-FN4-FN2	1.22(31.0)	0.75(19.1)	0.34(8.6)	6600 (454)	3300 (227)
1/4	1/4	-THC-FN4	1.19(30.2)	0.75(19.1)	0.45(11.4)	6600 (454)	3300 (227)
3/8	1/4	-THC-FN6-FN4	1.38(35.1)	0.87(22.2)	0.45 (11.4)	5300 (365)	2600 (179)
3/8	3/8	-THC-FN6	1.31(33.3)	0.87(22.2)	0.59(15.0)	5300 (365)	2600 (179)
1/2	1/8	-THC-FN8-FN2	1.56(39.6)	1.06(27.0)	0.34 (8.6)	4900 (337)	2400 (165)
1/2	1/4	-THC-FN8-FN4	1.75(44.4)	1.06(27.0)	0.45(11.4)	4900 (337)	2400 (165)
1/2	3/8	-THC-FN8-FN6	1.78(45.2)	1.06(27.0)	0.59 15.0)	4900 (337)	2400 (165)
1/2	1/2	-THC-FN8	1.56(39.6)	1.06(27.0)	0.73(18.5)	4900 (337)	2400 (165)
3/4	1/4	-THC-FN12-FN4	1.81(46.0)	1.31(33.3)	0.45(11.4)	4600 (316)	2300 (158)
3/4	1/2	-THC-FN12-FN8	2.06(52.3)	1.31(33.3)	0.73(18.5)	4600 (316)	2300 (158)
3/4	3/4	-THC-FN12	1.62(41.1)	1.31(33.3)	0.94(23.9)	4600 (316)	2300 (158)
1	1/2	-THC-FN16-FN8	2.19(55.6)	1.63(41.3)	0.73(18.5)	4400 (303)	2200 (151)
1	3/4	-THC-FN16-FN12	2.25(57.2)	1.63(41.3)	0.94(23.9)	4400 (303)	2200 (151)
1	1	-THC-FN16	2.00(50.8)	1.63(41.3)	1.17(29.7)	4400 (303)	2200 (151)
1 1/4	1	-THC-FN20	2.25(57.2)	21.3(54.0)	1.17(29.7)	4400 (303)	2200 (151)
1 1/4	1 1/4	-THC-FN20	2.00(50.8)	21.3(54.0)	1.49(37.8)	4400 (303)	2200 (151)
Heavy-Wall Female NPT Threads							
1/16	1/16	-THC-FN1-10K	0.78(19.8)	0.56 (14.3)	0.19(4.8)	10000(689)	-
1/8	1/8	-THC-FN2-10K	0.81(20.6)	0.56 (14.3)	0.34(8.6)	10000(689)	-
1/4	1/4	-THC-N4-10K	1.19(30.2)	0.75(19.1)	0.45(11.4)	10000(689)	-
3/8	3/8	-THC-FN6-10K	1.31(33.3)	1.06(27.0)	0.59(15.0)	10000(689)	-
1/2	1/2	-THC-N8-10K	1.56(39.6)	1.50(38.1)	0.73(18.5)	10000(689)	-
3/4	3/4	-THC-FN12-10K	1.62(41.1)	1.63(41.3)	0.94(23.9)	10000(689)	-
1	1	-THC-FN16-10K	2.00(50.8)	2.00 (50.8)	1.17(29.7)	10000(689)	-

Hex Couplings

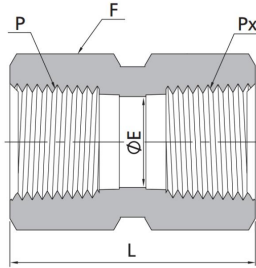

Female ISO Tapered Threads							
P-RT Size	Px-RT Size	Basic Ordering Number	Dimension, in(mm)			Working Pressure psig(bar)	
			L	F (Hex)	E	316SS, Steel	Brass
1/8	1/8	-THC-FR2	0.81(20.6)	0.56(14.3)	0.33 (8.4)	6500 (447)	3200 (220)
1/4	1/4	-THC-FR4	1.19(30.2)	0.75(19.1)	0.44(11.2)	6600 (454)	3300 (227)
3/8	3/8	-THC-FR6	1.31(33.3)	0.87(22.2)	0.58(14.7)	5300 (365)	2600 (179)
1/2	1/2	-THC-FR8	1.56(39.6)	1.06(27.0)	0.72(18.3)	4900 (337)	2400 (165)
3/4	3/4	-THC-FR12	1.62(41.1)	1.31(33.3)	0.94(23.9)	4600 (316)	2300 (158)
1	1	-THC-FR16	2.00(50.8)	1.63(41.3)	1.17(29.7)	4400 (303)	2200 (151)

Union Ball Joints

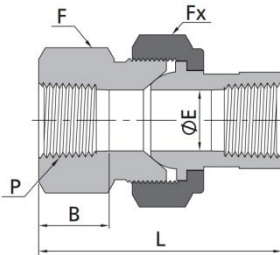

Female NPT Threads							
P-NPT Size	Basic Ordering Number	Dimension, in(mm)					Working Pressure psig(bar)
		L	F	Fx (Hex)	B	E	316SS, Steel
1/8	-TUJ-FN2	1.81(46.0)	0.94(23.8)	1.13(28.6)	0.41(10.4)	0.27(6.8)	8400(578)
1/4	-TUJ-FN4	2.34(59.4)	1.19(30.2)	1.37(34.9)	0.59(15.0)	0.36(9.1)	6600(454)
3/8	-TUJ-FN6	2.50(63.5)	1.31(33.3)	1.50(38.1)	0.59(15.0)	0.52(13.2)	5300(365)
1/2	-TUJ-FN8	2.69(68.3)	1.63(41.3)	1.75(44.5)	0.78 (19.8)	0.62(15.7)	6000(410)
3/4	-TUJ-FN12	3.12(79.2)	1.87(47.6)	2.13(54.0)	0.81(20.6)	0.88(22.4)	4600(316)
1	-TUJ-FN16	3.56(90.4)	2.37(60.3)	2.50(63.5)	1.00(25.4)	1.03(26.2)	6800(468)

Female NPT Threads							
P-NPT Size	Basic Ordering Number	Dimension, in(mm)					Working Pressure psig(bar)
		L	F	Fx (Hex)	B	E	316SS, Steel
1/8	-TUJ-FR2	1.81 (46.0)	0.94 (23.8)	1.13(28.6)	0.41(10.4)	0.27 (6.8)	8400 (578)
1/4	-TUJ-FR4	2.34 (59.4)	1.19 (30.2)	1.37(34.9)	0.59(15.0)	0.36 (9.1)	6600 (454)
3/8	-TUJ-FR6	2.50 (63.5)	1.31 (33.3)	1.50(38.1)	0.59(15.0)	0.52(13.2)	5300 (365)
1/2	-TUJ-FR8	2.69 (68.3)	1.63 (41.3)	1.75(44.5)	0.78 (19.8)	0.62(15.7)	6000 (410)
3/4	-TUJ-FR12	3.12 (79.2)	1.87 (47.6)	2.13(54.0)	0.81(20.6)	0.88(22.4)	4600 (316)
1	-TUJ-FR16	3.56 (90.4)	2.37 (60.3)	2.50(63.5)	1.00(25.4)	1.03(26.2)	6800 (468)

Male Elbows

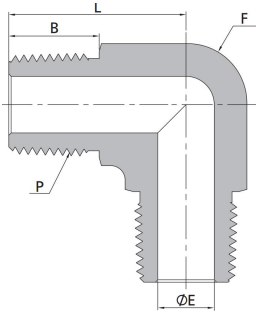

Male NPT Threads							
P-NPT Size	Basic Ordering Number	Dimension, in(mm)				Working Pressure psig(bar)	
		L	F	B	E	316SS, Steel	Brass
1/16	-TME-MN1	0.72 (18.3)	0.37 (9.5)	0.38 (9.7)	0.12(3.0)	11000(757)	5500(378)
1/8	-TME-MN2	0.88 (22.4)	0.44(11.1)	0.38 (9.7)	0.19(4.8)	10000(689)	5000(344)
1/4	-TME-MN4	1.05 (26.7)	0.50(12.7)	0.56(14.2)	0.28(7.1)	8000 (551)	4000(275)
3/8	-TME-MN6	1.17 (29.7)	0.69(17.5)	0.56(14.2)	0.38(9.6)	7800 (537)	3900(268)
1/2	-TME-MN8	1.45 (36.8)	0.81(20.6)	0.75(19.1)	0.47(11.9)	7700 (530)	3800(261)
3/4	-TME-MN12	1.59 (40.4)	1.06(27.0)	0.75(19.1)	0.62(15.7)	7300 (502)	3600(248)
1	-TME-MN16	1.97 (50.0)	1.37(34.9)	0.94(23.9)	0.88(22.4)	5300 (365)	2600(179)

Male ISO Tapered Threads							
P-RT Size	Basic Ordering Number	Dimension, in(mm)				Working Pressure psig(bar)	
		L	F	B	E	316SS, Steel	Brass
1/16	-TME-MR1	0.72(18.3)	0.37(9.5)	0.38 (9.7)	0.12(3.0)	11000(757)	5500(378)
1/8	-TME-MR2	0.88(22.4)	0.44(11.1)	0.38 (9.7)	0.19(4.8)	10000(689)	5000(344)
1/4	-TME-MR4	1.05(26.7)	0.50(12.7)	0.56(14.)	0.28(7.1)	8000 (551)	4000(275)
3/8	-TME-MR6	1.17(29.7)	0.69(17.5)	0.56(14.)	0.38(9.6)	7800 (537)	3900(268)
1/2	-TME-MR8	1.45(36.8)	0.81(20.6)	0.75(19.)	0.47(11.9)	7700 (530)	3800(261)
3/4	-TME-MR12	1.59(40.4)	1.06(27.0)	0.75(19.1)	0.62(15.7)	7300 (502)	3600(248)
1	-TME-MR16	1.97(50.0)	1.37(34.9)	0.94(23.9)	0.88(22.4)	5300 (365)	2600(179)

Female Elbows

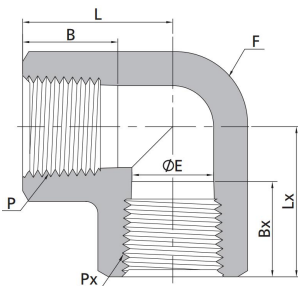

Female NPT Threads										
P-NPT Size	Px-NP T Size	Basic Ordering Number	Dimension, in(mm)						Working Pressure psig(bar)	
			L	F (Flat)	B	E	Lx	Bx	316SS, Steel	Brass
1/16	1/16	-TFE-FN1	0.86 (21.8)	0.44 (11.1)	0.39 (9.9)	0.19 (4.8)	0.86 (21.8)	0.39 (9.9)	6700 (460)	3300 (227)
1/8	1/8	-TFE-FN2	1.04 (26.4)	0.50 (12.7)	0.41 (10.4)	0.28 (7.1)	1.04 (26.4)	0.41 (10.4)	6200 (427)	3100 (213)
1/4	1/8	-TFE-FN4-FN2	1.17 (29.7)	0.69 (17.5)	0.59 (15.0)	0.28 (7.1)	1.17 (29.7)	0.41 (10.4)	7200 (496)	3600 (248)
1/4	1/4	-TFE-FN4	1.17 (29.7)	0.69 (17.5)	0.59 (15.0)	0.41 (10.4)	1.17 (29.7)	0.59 (15.0)	7200 (496)	3600 (248)
3/8	3/8	-TFE-FN6	1.42 (36.1)	0.81 (20.6)	0.59 (15.0)	0.50 (12.7)	1.42 (36.1)	0.59 (15.0)	5600 (385)	2800 (192)
1/2	1/2	-TFE-FN8	1.56 (39.6)	1.00 (25.4)	0.78 (19.8)	0.67 (17.1)	1.56 (39.6)	0.78 (19.8)	5600 (385)	2800 (192)
3/4	3/4	-TFE-FN12	1.92 (48.8)	1.25 (31.8)	0.81 (20.6)	0.88 (22.4)	1.92 (48.8)	0.81 (20.6)	5100 (351)	2500 (172)
1	1	-TFE-FN16	1.91 (48.5)	1.69 (42.9)	1.00 (25.4)	1.11 (28.1)	1.91 (48.5)	1.00 (25.4)	6400 (440)	3200 (220)
1 1/4	1 1/4	TFE-FN20	2.35 (59.8)	2.00 (50.8)	1.00 (25.4)	1.09 (27.7)	2.35 (59.8)	1.00 (25.4)	3100 (213)	1600 (110)

13 Pipe Fittings

Female ISO Tapered Threads										
P-RT Size	Px-RT Size	Basic Ordering Number	Dimension,in(mm)						Working Pressure psig(bar)	
			L	F (Flat)	B	E	Lx	Bx	316SS,Steel	Brass
1/16	1/16	-TFE-FR1	0.86 (21.8)	0.44 (11.1)	0.39 (9.9)	0.19 (4.8)	0.86 (21.8)	0.39 (9.9)	6700 (460)	3300 (227)
1/8	1/16	-TFE-FR2-FR1	1.04 (26.4)	0.50 (12.7)	0.41 (10.4)	0.19 (4.8)	1.04 (26.4)	0.39 (9.9)	6200 (427)	3100 (213)
1/8	1/8	-TFE-FR2	1.04 (26.4)	0.50 (12.7)	0.41 (10.4)	0.28 (7.1)	1.04 (26.4)	0.41 (10.4)	6200 (427)	3100 (213)
1/4	1/8	-TFE-FR4-FR2	1.17 (29.7)	0.69 (17.5)	0.59 (15.0)	0.28 (7.1)	1.17 (29.7)	0.41 (10.4)	7200 (496)	3600 (248)
1/4	1/4	-TFE-FR4	1.17 (29.7)	0.69 (17.5)	0.59 (15.0)	0.41 (10.4)	1.17 (29.7)	0.59 (15.0)	7200 (496)	3600 (248)
3/8	3/8	-TFE-FR6	1.42 (36.1)	0.81 (20.6)	0.59 (15.0)	0.50 (12.7)	1.42 (36.1)	0.59 (15.0)	5600 (385)	2800 (192)
1/2	1/2	-TFE-FR8	1.56 (39.6)	1.00 (25.4)	0.78 (19.8)	0.67 (17.1)	1.56 (39.6)	0.78 (19.8)	5600 (385)	2800 (192)
3/4	3/4	-TFE-FR12	1.92 (48.8)	1.25 (31.8)	0.81 (20.6)	0.88 (22.4)	1.92 (48.8)	0.81 (20.6)	5100 (351)	2500 (172)
1	1	-TFE-FR16	1.91 (48.5)	1.69 (42.9)	1.00 (25.4)	1.11 (28.1)	1.91 (48.5)	1.00 (25.4)	6400 (440)	3200 (220)

45° Female Elbows

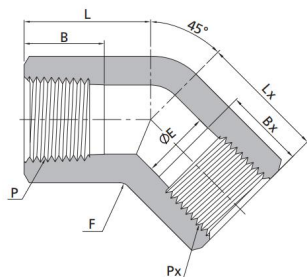

Female NPT Threads										
P-NPT Size	Px-NP T Size	Basic Ordering Number	Dimension,in(mm)						Working Pressure psig(bar)	
			L	F (Flat)	B	E	Lx	Bx	316SS,Steel	Brass
1/16	1/16	-TFV-FN1	0.66 (16.8)	0.44 (11.1)	0.39 (9.9)	0.19 (4.8)	0.66 (16.8)	0.39 (9.9)	6700 (460)	3300(227)
1/8	1/16	-TFV-FN2-FN1	0.80 (20.2)	0.50 (12.7)	0.41 (10.4)	0.19 (4.8)	0.80 (20.2)	0.39 (9.9)	6200 (427)	3100(213)
1/8	1/8	-TFV-FN2	0.80 (20.2)	0.50 (12.7)	0.41 (10.4)	0.28 (7.1)	0.80 (20.2)	0.41 (10.4)	6200 (427)	3100(213)
1/4	1/8	-TFV-FN4-FN2	1.00 (25.4)	0.69 (17.5)	0.59 (15.0)	0.28 (7.1)	1.00 (25.4)	0.41 (10.4)	7200 (496)	3600(248)
1/4	1/4	-TFV-FN4	1.00 (25.4)	0.69 (17.5)	0.59 (15.0)	0.41 (10.4)	1.00 (25.4)	0.59 (15.0)	7200 (496)	3600(248)
3/8	3/8	-TFV-FN6	1.06 (27.0)	0.81 (20.6)	0.59 (15.0)	0.50 (12.7)	1.06 (27.0)	0.59 (15.0)	5600 (385)	2800(192)
1/2	1/2	-TFV-FN8	1.26 (32.0)	1.00 (25.4)	0.78 (19.8)	0.67 (17.1)	1.26 (32.0)	0.78 (19.8)	5600 (385)	2800(192)
3/4	3/4	-TFV-FN12	1.36 (34.5)	1.25 (31.8)	0.81 (20.6)	0.88 (22.4)	1.36 (34.5)	0.81 (20.6)	5100 (351)	2500(172)
1	1	-TFV-FN16	1.81 (46.0)	1.69 (42.9)	1.00 (25.4)	1.11 (28.1)	1.81 (46.0)	1.00 (25.4)	6400 (440)	3200(220)
1 1/4	1 1/4	-TFV-FN20	1.70 (43.2)	2.00 (50.8)	1.00 (25.4)	1.09 (27.7)	1.70 (43.2)	1.00 (25.4)	3100 (213)	1600(110)
1 1/2	1 1/2	-TFV-FN24	1.81 (46.0)	2.50 (63.5)	1.09 (27.7)	1.34 (34.0)	1.81 (46.0)	1.09 (27.7)	5100 (351)	2500(172)

Female ISO Tapered Threads										
P-RT Size	Px-RT Size	Basic Ordering Number	Dimension,in(mm)						Working Pressure psig(bar)	
			L	F (Flat)	B	E	Lx	Bx	316SS,Steel	Brass
1/16	1/16	-TFV-FR1	0.66 (16.8)	0.44 (11.1)	0.39 (9.9)	0.19 (4.8)	0.66 (16.8)	0.39 (9.9)	6700 (460)	3300(227)
1/8	1/16	-TFV-FR2-FR1	0.80 (20.2)	0.50 (12.7)	0.41 (10.4)	0.19 (4.8)	0.80 (20.2)	0.39 (9.9)	6200 (427)	3100(213)
1/8	1/8	-TFV-FR2	0.80 (20.2)	0.50 (12.7)	0.41 (10.4)	0.28 (7.1)	0.80 (20.2)	0.41 (10.4)	6200 (427)	3100(213)
1/4	1/8	-TFV-RT4-FR2	1.00 (25.4)	0.69 (17.5)	0.59 (15.0)	0.28 (7.1)	1.00 (25.4)	0.41 (10.4)	7200 (496)	3600(248)
1/4	1/4	-TFV-FR4	1.00 (25.4)	0.69 (17.5)	0.59 (15.0)	0.41 (10.4)	1.00 (25.4)	0.59 (15.0)	7200 (496)	3600(248)
3/8	3/8	-TFV-FR6	1.06 (27.0)	0.81 (20.6)	0.59 (15.0)	0.50 (12.7)	1.06 (27.0)	0.59 (15.0)	5600 (385)	2800(192)
1/2	1/2	-TFV-FR8	1.26 (32.0)	1.00 (25.4)	0.78 (19.8)	0.67 (17.1)	1.26 (32.0)	0.78 (19.8)	5600 (385)	2800(192)
3/4	3/4	-TFV-FR12	1.36 (34.5)	1.25 (31.8)	0.81 (20.6)	0.88 (22.4)	1.36 (34.5)	0.81 (20.6)	5100 (351)	2500(172)
1	1	-TFV-FR16	1.81 (46.0)	1.69 (42.9)	1.00 (25.4)	1.11 (28.1)	1.81 (46.0)	1.00 (25.4)	6400 (440)	3200(220)
1 1/4	1 1/4	-TFV-FR20	1.70 (43.2)	2.00 (50.8)	1.00 (25.4)	1.09 (27.7)	1.70 (43.2)	1.00 (25.4)	3100 (213)	1600(110)
1 1/2	1 1/2	-TFV-FR24	1.81 (46.0)	2.50 (63.5)	1.09 (27.7)	1.34 (34.0)	1.81 (46.0)	1.09 (27.7)	5100 (351)	2500(172)

Street Elbows

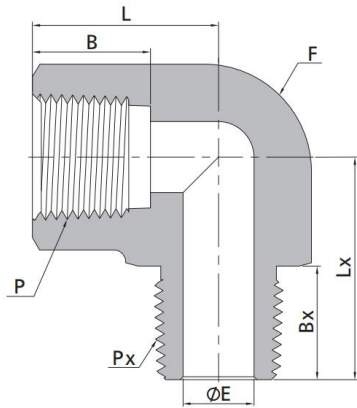

Female NPT Threads to Male NPT Thread

P-NPT Size	Px-NPT Size	Basic Ordering Number	Dimension,in(mm)						Working Pressure psig(bar)	
			L	F (Flat)	B	E	Lx	Bx	316SS,Steel	Brass
1/16	1/16	-TSE-FN1-MN1	0.86 (21.8)	0.44 (11.1)	0.39 (9.9)	0.12 (3.0)	0.88 (22.4)	0.38 (9.7)	9200(633)	4600(316)
1/16	1/8	-TSE-FN1-MN2	0.86 (21.8)	0.44 (11.1)	0.39 (9.9)	0.19 (4.8)	0.88 (22.4)	0.38 (9.7)	9200 (633)	4600 (316)
1/16	1/4	-TSE-FN1-MN4	0.88 (22.4)	0.56 (14.3)	0.39 (9.9)	0.19 (4.8)	1.09 (27.7)	0.56 (14.2)	8000 (551)	4000 (275)
1/16	3/8	-TSE-FN1-MN6	0.88 (22.4)	0.69 (17.5)	0.39 (9.9)	0.19 (4.8)	1.17 (29.7)	0.56 (14.2)	7800 (537)	3900 (268)
1/8	1/16	-TSE-FN2-MN1	1.04 (26.4)	0.50 (12.7)	0.41 (10.4)	0.12 (3.0)	0.87 (22.1)	0.38 (9.7)	6200 (426)	3100 (213)
1/8	1/8	-TSE-FN2-MN2	1.04 (26.4)	0.50 (12.7)	0.41 (10.4)	0.19 (4.8)	0.87 (22.1)	0.38 (9.7)	6200 (426)	3100 (213)
1/8	1/4	-TSE-FN2-MN4	0.88 (22.4)	0.56 (14.3)	0.41 (10.4)	0.28 (7.1)	1.09 (27.7)	0.56 (14.2)	6500 (447)	3200 (220)
1/8	3/8	-TSE-FN2-MN6	0.88 (22.4)	0.69 (17.5)	0.41 (10.4)	0.28 (7.1)	1.17 (29.7)	0.56 (14.2)	7800 (537)	3900 (268)
1/8	1/2	-TSE-FN2-MN8	0.95 (24.1)	0.81 (20.6)	0.41 (10.4)	0.28 (7.1)	1.45 (36.8)	0.75 (19.1)	7700 (530)	3800 (261)
1/8	3/4	-TSE-FN2-MN12	1.00 (25.4)	1.06 (27.0)	0.41 (10.4)	0.28 (7.1)	1.59 (40.4)	0.75 (19.1)	7300 (502)	3600 (248)
1/8	1	-TSE-FN2-MN16	1.04 (26.4)	1.37 (34.9)	0.41 (10.4)	0.28 (7.1)	1.97 (50.0)	0.94 (23.9)	5300 (365)	2600 (179)
1/4	1/8	-TSE-FN4-MN2	1.17 (29.7)	0.69 (17.5)	0.59 (15.0)	0.19 (4.8)	1.00 (25.4)	0.38 (9.7)	7200 (496)	3600 (248)
1/4	1/4	-TSE-FN4-MN4	1.17 (29.7)	0.69 (17.5)	0.59 (15.0)	0.28 (7.1)	1.17 (29.7)	0.56 (14.2)	7200 (496)	3600 (248)
1/4	3/8	-TSE-FN4-MN6	1.17 (29.7)	0.69 (17.5)	0.59 (15.0)	0.34 (8.6)	1.17 (29.7)	0.56 (14.2)	7200 (496)	3600 (248)
1/4	1/2	-TSE-FN4-MN8	1.00 (25.4)	0.81 (20.6)	0.59 (15.0)	0.34 (8.6)	1.45 (36.8)	0.75 (19.1)	7200 (496)	3600 (248)
1/4	3/4	-TSE-FN4-MN12	1.00 (25.4)	1.06 (27.0)	0.59 (15.0)	0.34 (8.6)	1.59 (40.4)	0.75 (19.1)	7300 (502)	3600 (248)
1/4	1	-TSE-FN4-MN16	1.63 (41.4)	1.37 (34.9)	0.59 (15.0)	0.34 (8.6)	1.97 (50.0)	0.94 (23.9)	5300 (365)	2600 (179)
3/8	1/4	-TSE-FN6-MN4	1.42 (36.1)	0.81 (20.6)	0.59 (15.0)	0.28 (7.1)	1.26 (32.0)	0.56 (14.2)	5600 (385)	2800 (192)
3/8	3/8	-TSE-FN6-MN6	1.42 (36.1)	0.81 (20.6)	0.59 (15.0)	0.38 (9.6)	1.26 (32.0)	0.56 (14.2)	5600 (385)	2800 (192)
3/8	1/2	-TSE-FN6-MN8	1.42 (36.1)	0.81 (20.6)	0.59 (15.0)	0.47(11.9)	1.45 (36.8)	0.75 (19.1)	5600 (385)	2800 (192)
3/8	3/4	-TSE-FN6-MN12	1.23 (31.2)	1.06 (27.0)	0.59 (15.0)	0.47(11.9)	1.59 (40.4)	0.75 (19.1)	7300 (502)	3600 (248)
3/8	1	-TSE-FN6-MN16	1.63 (41.4)	1.37 (34.9)	0.59 (15.0)	0.47(11.9)	1.97 (50.0)	0.94 (23.9)	5300 (365)	2600 (179)
1/2	1/4	-TSE-FN8-MN4	1.56 (39.6)	1.00 (25.4)	0.78 (19.8)	0.28 (7.1)	1.38 (35.1)	0.56 (14.2)	5600 (385)	2800 (192)
1/2	3/8	-TSE-FN8-MN6	1.56 (39.6)	1.00 (25.4)	0.78 (19.8)	0.38 (9.6)	1.38 (35.1)	0.56 (14.2)	5600 (385)	2800 (192)
1/2	1/2	-TSE-FN8-MN8	1.56 (39.6)	1.00 (25.4)	0.78 (19.8)	0.47(11.9)	1.56 (39.6)	0.75 (19.1)	5600 (385)	2800 (192)
1/2	3/4	-TSE-FN8-MN12	1.23 (31.2)	1.06 (27.0)	0.78 (19.8)	0.62(15.7)	1.59 (40.4)	0.75 (19.1)	5600 (385)	2800 (192)
1/2	1	-TSE-FN8-MN16	1.63 (41.4)	1.37 (34.9)	0.78 (19.8)	0.62(15.7)	1.97 (50.0)	0.94 (23.9)	5300 (365)	2600 (179)
3/4	3/4	-TSE-FN12-MN12	1.92 (48.8)	1.25 (31.8)	0.81 (20.6)	0.62(15.7)	1.67 (42.4)	0.75 (19.1)	5100 (351)	2500 (172)
1	1	-TSE-FN16-MN16	1.91 (48.5)	1.69 (42.9)	1.00 (25.4)	0.88(22.4)	0.88 (22.4)	0.94 (23.9)	5300 (365)	2600 (179)
1 1/4	1 1/4	-TSE-FN20-MN20	2.38(60.5)	2.00(50.8)	1.00(25.4)	1.25(31.8)	2.38(60.5)	0.94(23.9)	3100(213)	1600(110)

Street Elbows

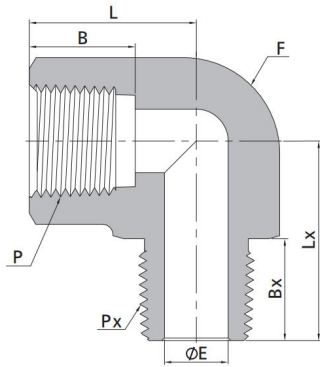

Female ISO Tapered Threads to Male ISO Tapered Thread

P-RT Size	Px-RT Size	Basic Ordering Number	Dimension, in(mm)						Working Pressure psig(bar)	
			L	F (Flat)	B	E	Lx	Bx	316SS, Steel	Brass
1/16	1/16	-TSE-FR1-MR1	0.86 (21.8)	0.44 (11.1)	0.39 (9.9)	0.12 (3.0)	0.88 (22.4)	0.38 (9.7)	9200(633)	4600(316)
1/16	1/8	-TSE-FR1-MR2	0.86 (21.8)	0.44 (11.1)	0.39 (9.9)	0.19 (4.8)	0.88 (22.4)	0.38 (9.7)	9200 (633)	4600 (316)
1/16	1/4	-TSE-FR1-MR4	0.88 (22.4)	0.56 (14.3)	0.39 (9.9)	0.19 (4.8)	1.09 (27.7)	0.56 (14.2)	8000 (551)	4000 (275)
1/16	3/8	-TSE-FR1-MR6	0.88 (22.4)	0.69 (17.5)	0.39 (9.9)	0.19 (4.8)	1.17 (29.7)	0.56 (14.2)	7800 (537)	3900 (268)
1/8	1/16	-TSE-FR2-MR1	1.04 (26.4)	0.50 (12.7)	0.41 (10.4)	0.12 (3.0)	0.87 (22.1)	0.38 (9.7)	6200 (426)	3100 (213)
1/8	1/8	-TSE-FR2-MR2	1.04 (26.4)	0.50 (12.7)	0.41 (10.4)	0.19 (4.8)	0.87 (22.1)	0.38 (9.7)	6200 (426)	3100 (213)
1/8	1/4	-TSE-FR2-MR4	0.88 (22.4)	0.56 (14.3)	0.41 (10.4)	0.28 (7.1)	1.09 (27.7)	0.56 (14.2)	6500 (447)	3200 (220)
1/8	3/8	-TSE-FR2-MR6	0.88 (22.4)	0.69 (17.5)	0.41 (10.4)	0.28 (7.1)	1.17 (29.7)	0.56 (14.2)	7800 (537)	3900 (268)
1/8	1/2	-TSE-FR2-MR8	0.95 (24.1)	0.81 (20.6)	0.41 (10.4)	0.28 (7.1)	1.45 (36.8)	0.75 (19.1)	7700 (530)	3800 (261)
1/8	3/4	-TSE-FR2-MR12	1.00 (25.4)	1.06 (27.0)	0.41 (10.4)	0.28 (7.1)	1.59 (40.4)	0.75 (19.1)	7300 (502)	3600 (248)
1/8	1	-TSE-FR2-MR16	1.04 (26.4)	1.37 (34.9)	0.41 (10.4)	0.28 (7.1)	1.97 (50.0)	0.94 (23.9)	5300 (365)	2600 (179)
1/4	1/8	-TSE-FR4-MR2	1.17 (29.7)	0.69 (17.5)	0.59 (15.0)	0.19 (4.8)	1.00 (25.4)	0.38 (9.7)	7200 (496)	3600 (248)
1/4	1/4	-TSE-FR4-MR4	1.17 (29.7)	0.69 (17.5)	0.59 (15.0)	0.28 (7.1)	1.17 (29.7)	0.56 (14.2)	7200 (496)	3600 (248)
1/4	3/8	-TSE-FR4-MR6	1.17 (29.7)	0.69 (17.5)	0.59 (15.0)	0.34 (8.6)	1.17 (29.7)	0.56 (14.2)	7200 (496)	3600 (248)
1/4	1/2	-TSE-FR4-MR8	1.00 (25.4)	0.81 (20.6)	0.59 (15.0)	0.34 (8.6)	1.45 (36.8)	0.75 (19.1)	7200 (496)	3600 (248)
1/4	3/4	-TSE-FR4-MR12	1.00 (25.4)	1.06 (27.0)	0.59 (15.0)	0.34 (8.6)	1.59 (40.4)	0.75 (19.1)	7300 (502)	3600 (248)
1/4	1	-TSE-FR4-MR16	1.63 (41.4)	1.37 (34.9)	0.59 (15.0)	0.34 (8.6)	1.97 (50.0)	0.94 (23.9)	5300 (365)	2600 (179)
3/8	1/4	-TSE-FR6-MR4	1.42 (36.1)	0.81 (20.6)	0.59 (15.0)	0.28 (7.1)	1.26 (32.0)	0.56 (14.2)	5600 (385)	2800 (192)
3/8	3/8	-TSE-FR6-MR6	1.42 (36.1)	0.81 (20.6)	0.59 (15.0)	0.38 (9.6)	1.26 (32.0)	0.56 (14.2)	5600 (385)	2800 (192)
3/8	1/2	-TSE-FR6-MR8	1.42 (36.1)	0.81 (20.6)	0.59 (15.0)	0.47 (11.9)	1.45 (36.8)	0.75 (19.1)	5600 (385)	2800 (192)
3/8	3/4	-TSE-FR6-MR12	1.23 (31.2)	1.06 (27.0)	0.59 (15.0)	0.47 (11.9)	1.59 (40.4)	0.75 (19.1)	7300 (502)	3600 (248)
3/8	1	-TSE-FR6-MR16	1.63 (41.4)	1.37 (34.9)	0.59 (15.0)	0.47 (11.9)	1.97 (50.0)	0.94 (23.9)	5300 (365)	2600 (179)
1/2	1/4	-TSE-FR8-MR4	1.56 (39.6)	1.00 (25.4)	0.78 (19.8)	0.28 (7.1)	1.38 (35.1)	0.56 (14.2)	5600 (385)	2800 (192)
1/2	3/8	-TSE-FR8-MR6	1.56 (39.6)	1.00 (25.4)	0.78 (19.8)	0.38 (9.6)	1.38 (35.1)	0.56 (14.2)	5600 (385)	2800 (192)
1/2	1/2	-TSE-FR8-MR8	1.56 (39.6)	1.00 (25.4)	0.78 (19.8)	0.47 (11.9)	1.56 (39.6)	0.75 (19.1)	5600 (385)	2800 (192)
1/2	3/4	-TSE-FR8-MR12	1.23 (31.2)	1.06 (27.0)	0.78 (19.8)	0.62 (15.7)	1.59 (40.4)	0.75 (19.1)	5600 (385)	2800 (192)
1/2	1	-TSE-FR8-MR16	1.63 (41.4)	1.37 (34.9)	0.78 (19.8)	0.62 (15.7)	1.97 (50.0)	0.94 (23.9)	5300 (365)	2600 (179)
3/4	3/4	-TSE-FR12-MR12	1.92 (48.8)	1.25 (31.8)	0.81 (20.6)	0.62 (15.7)	1.67 (42.4)	0.75 (19.1)	5100 (351)	2500 (172)
3/4	1	-TSE-FR12-MR16	1.63 (41.4)	1.37 (34.9)	0.81 (20.6)	0.88 (22.4)	1.97 (50.0)	0.94 (23.9)	5100 (351)	2500 (172)
1	1	-TSE-FR16-MR16	1.91 (48.5)	1.69 (42.9)	1.00 (25.4)	0.88 (22.4)	0.88 (22.4)	0.94 (23.9)	5300 (365)	2600 (179)
1 1/4	1 1/4	-TSE-FR20-MR20	2.38(60.5)	2.00(50.8)	1.00(25.4)	1.25(31.8)	2.38(60.5)	0.94(23.9)	3100(213)	1600(110)

45° Street Elbows

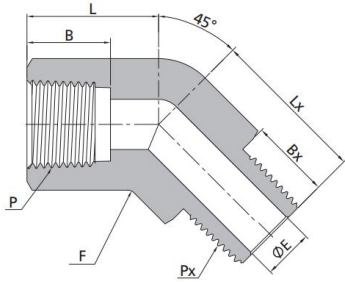

Female NPT Threads to Male NPT Thread

P-NPT Size	Px-NPT Size	Basic Ordering Number	Dimension, in(mm)						Working Pressure psig(bar)	
			L	F (Flat)	B	E	Lx	Bx	316SS, Steel	Brass
1/16	1/16	-TSV-FN1-MN1	0.66 (16.8)	0.44 (11.1)	0.39 (9.9)	0.12 (3.0)	0.66 (16.8)	0.38 (9.7)	9200(633)	4600(316)
1/16	1/8	-TSV-FN1-MN2	0.66 (16.8)	0.44 (11.1)	0.39 (9.9)	0.19 (4.8)	0.66 (16.8)	0.38(9.7)	9200(633)	4600(316)
1/8	1/16	-TSV-FN2-MN1	0.80 (20.2)	0.50 (12.7)	0.41 (10.4)	0.12 (3.0)	0.68 (17.2)	0.38 (9.7)	6200(426)	3100(213)
1/8	1/8	-TSV-FN2-MN2	0.80 (20.2)	0.50 (12.7)	0.41 (10.4)	0.19 (4.8)	0.68 (17.2)	0.38(9.7)	6200(426)	3100(213)
1/8	1/4	-TSV-FN2-MN4	0.66 (16.8)	0.56 (14.3)	0.41 (10.4)	0.28 (7.1)	0.86 (21.8)	0.56(14.2)	6500 (447)	3200 (220)
1/4	1/8	-TSV-FN4-MN2	1.00 (25.4)	0.69 (17.5)	0.59 (15.0)	0.19 (4.8)	0.76 (19.3)	0.38(9.7)	7200 (496)	3600 (248)
1/4	1/4	-TSV-FN4-MN4	1.00 (25.4)	0.69 (17.5)	0.59 (15.0)	0.28 (7.1)	0.76 (19.3)	0.56(14.2)	7200 (496)	3600 (248)
1/4	3/8	-TSV-FN4-MN6	1.00 (25.4)	0.69 (17.5)	0.59 (15.0)	0.34 (8.6)	0.94 (23.8)	0.56(14.2)	7200 (496)	3600 (248)
3/8	1/4	-TSV-FN6-MN4	1.06 (27.0)	0.81 (20.6)	0.59 (15.0)	0.28 (7.1)	0.95 (24.2)	0.56(14.2)	5600 (385)	2800 (192)
3/8	3/8	-TSV-FN6-MN6	1.06 (27.0)	0.81 (20.6)	0.59 (15.0)	0.38 (9.6)	0.95 (24.2)	0.56(14.2)	5600 (385)	2800 (192)
3/8	1/2	-TSV-FN6-MN8	1.06 (27.0)	0.81 (20.6)	0.59 (15.0)	0.47(11.9)	1.14 (29.0)	0.75(19.1)	5600 (385)	2800 (192)
1/2	1/4	-TSV-FN8-MN4	1.26 (32.0)	1.00 (25.4)	0.78 (19.8)	0.28 (7.1)	0.99 (25.2)	0.56(14.2)	5600 (385)	2800 (192)
1/2	3/8	-TSV-FN8-MN6	1.26 (32.0)	1.00 (25.4)	0.78 (19.8)	0.38 (9.6)	0.99 (25.2)	0.56(14.2)	5600 (385)	2800 (192)
1/2	1/2	-TSV-FN8-MN8	1.26 (32.0)	1.00 (25.4)	0.78 (19.8)	0.47(11.9)	1.26(32.0)	0.75(19.1)	5600(385)	2800 (192)
3/4	3/4	-TSV-FN12-MN12	1.36 (34.5)	1.25 (31.8)	0.81 (20.6)	0.62(15.7)	1.36 (34.5)	0.75 (19.1)	5100 (351)	2500 (172)
1	1	-TSV-FN16-MN16	1.81 (46.0)	1.69 (42.9)	1.00 (25.4)	0.88(22.4)	1.81 (46.0)	0.94(23.9)	5300 (365)	2600 (179)
1 1/4	1 1/4	-TSV-FN20-MN20	2.00 (50.8)	2.00 (50.8)	1.00 (25.4)	1.25(31.8)	2.00 (50.8)	0.94(23.9)	3100 (213)	1600 (110)

Female ISO Tapered Threads to Male ISO Tapered Thread

P-RT Size	Px-RT Size	Basic Ordering Number	Dimension, in(mm)						Working Pressure psig(bar)	
			L	F (Flat)	B	E	Lx	Bx	316SS, Steel	Brass
1/16	1/16	-TSV-FR1-MR1	0.66 (16.8)	0.44 (11.1)	0.39 (9.9)	0.12 (3.0)	0.66 (16.8)	0.38 (9.7)	9200(633)	4600(316)
1/16	1/8	-TSV-FR1-MR2	0.66 (16.8)	0.44 (11.1)	0.39 (9.9)	0.19 (4.8)	0.66 (16.8)	0.38(9.7)	9200(633)	4600(316)
1/8	1/16	-TSV-FR2-MR1	0.80 (20.2)	0.50 (12.7)	0.41 (10.4)	0.12 (3.0)	0.68 (17.2)	0.38 (9.7)	6200(426)	3100(213)
1/8	1/8	-TSV-FR2-MR2	0.80 (20.2)	0.50 (12.7)	0.41 (10.4)	0.19 (4.8)	0.68 (17.2)	0.38(9.7)	6200(426)	3100(213)
1/8	1/4	-TSV-FR2-MR4	0.66 (16.8)	0.56 (14.3)	0.41 (10.4)	0.28 (7.1)	0.86 (21.8)	0.56(14.2)	6500 (447)	3200 (220)
1/4	1/8	-TSV-FR4-MR2	1.00 (25.4)	0.69 (17.5)	0.59 (15.0)	0.19 (4.8)	0.76 (19.3)	0.38(9.7)	7200 (496)	3600 (248)
1/4	1/4	-TSV-FR4-MR4	1.00 (25.4)	0.69 (17.5)	0.59 (15.0)	0.28 (7.1)	0.76 (19.3)	0.56(14.2)	7200 (496)	3600 (248)
1/4	3/8	-TSV-FR4-MR6	1.00 (25.4)	0.69 (17.5)	0.59 (15.0)	0.34 (8.6)	0.94 (23.8)	0.56(14.2)	7200 (496)	3600 (248)
3/8	1/4	-TSV-FR6-MR4	1.06 (27.0)	0.81 (20.6)	0.59 (15.0)	0.28 (7.1)	0.95 (24.2)	0.56(14.2)	5600 (385)	2800 (192)
3/8	3/8	-TSV-FR6-MR6	1.06 (27.0)	0.81 (20.6)	0.59 (15.0)	0.38 (9.6)	0.95 (24.2)	0.56(14.2)	5600 (385)	2800 (192)
3/8	1/2	-TSV-FR6-MR8	1.06 (27.0)	0.81 (20.6)	0.59 (15.0)	0.47(11.9)	1.14 (29.0)	0.75(19.1)	5600 (385)	2800 (192)
1/2	1/4	-TSV-FR8-MR4	1.26 (32.0)	1.00 (25.4)	0.78 (19.8)	0.28 (7.1)	0.99 (25.2)	0.56(14.2)	5600 (385)	2800 (192)
1/2	3/8	-TSV-FR8-MR6	1.26 (32.0)	1.00 (25.4)	0.78 (19.8)	0.38 (9.6)	0.99 (25.2)	0.56(14.2)	5600 (385)	2800 (192)
1/2	1/2	-TSV-FR8-MR8	1.26 (32.0)	1.00 (25.4)	0.78 (19.8)	0.47(11.9)	1.26(32.0)	0.75(19.1)	5600(385)	2800 (192)
3/4	3/4	-TSV-FR12-MR12	1.36 (34.5)	1.25 (31.8)	0.81 (20.6)	0.62(15.7)	1.36 (34.5)	0.75 (19.1)	5100 (351)	2500 (172)
1	1	-TSV-FR16-MR16	1.81 (46.0)	1.69 (42.9)	1.00 (25.4)	0.88(22.4)	1.81 (46.0)	0.94(23.9)	5300 (365)	2600 (179)
1 1/4	1 1/4	-TSV-FR20-MR20	2.00 (50.8)	2.00 (50.8)	1.00 (25.4)	1.25(31.8)	2.00 (50.8)	0.94(23.9)	3100 (213)	1600 (110)

Male Tees

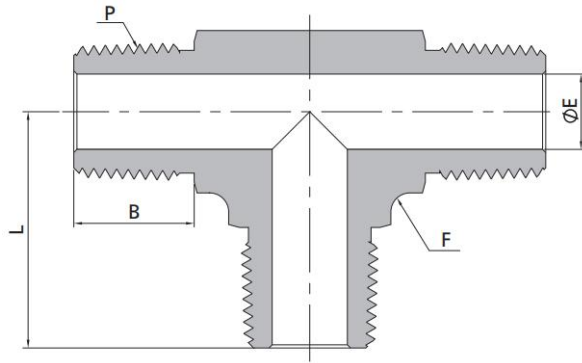

Male NPT Threads							
P-NPT Size	Basic Ordering Number	Dimension,in(mm)				Working Pressure psig(bar)	
		L	F (Hex)	B	E	316SS,Steel	Brass
1/16	-TMT-MN1	0.72 (18.3)	0.37 (9.5)	0.38 (9.7)	0.12 (3.0)	11000 (757)	5500 (378)
1/8	-TMT-MN2	0.88 (22.4)	0.44 (11.1)	0.38 (9.7)	0.19 (4.8)	10000 (689)	5000 (344)
1/4	-TMT-MN4	1.05 (26.7)	0.50 (12.7)	0.56 (14.2)	0.28 (7.1)	8000 (551)	4000 (275)
3/8	-TMT-MN6	1.17 (29.7)	0.69 (17.5)	0.56 (14.2)	0.38 (9.6)	7800 (537)	3900 (268)
1/2	-TMT-MN8	1.45 (36.8)	0.81 (20.6)	0.75 (19.1)	0.47 (11.9)	7700 (530)	3800 (261)
3/4	-TMT-MN12	1.67 (42.4)	1.06 (27.0)	0.75 (19.1)	0.62 (15.7)	7300 (502)	3600 (248)
1	-TMT-MN16	1.94 (49.3)	1.37 (34.9)	0.94 (23.9)	0.88 (22.4)	5300(365)	2600 (179)
1 1/4	-TMT-MN20	2.22 (56.4)	1.69 (42.9)	0.94 (23.9)	1.09 (27.7)	6000 (410)	3000 (200)
1 1/2	-TMT-MN24	2.64 (67.1)	1.87 (47.6)	1.03 (26.2)	1.34 (34.0)	5000 (344)	2500 (172)

Male ISO Tapered Threads							
P-RT Size	Basic Ordering Number	Dimension,in(mm)				Working Pressure psig(bar)	
		L	F (Hex)	B	E	316SS,Steel	Brass
1/16	-TMT-MR1	0.72 (18.3)	0.37 (9.5)	0.38 (9.7)	0.12 (3.0)	11000 (757)	5500 (378)
1/8	-TMT-MR2	0.88 (22.4)	0.44 (11.1)	0.38 (9.7)	0.19 (4.8)	10000 (689)	5000 (344)
1/4	-TMT-MR4	1.05 (26.7)	0.50 (12.7)	0.56 (14.2)	0.28 (7.1)	8000 (551)	4000 (275)
3/8	-TMT-MR6	1.17 (29.7)	0.69 (17.5)	0.56 (14.2)	0.38 (9.6)	7800 (537)	3900 (268)
1/2	-TMT-MR8	1.45 (36.8)	0.81 (20.6)	0.75 (19.1)	0.47 (11.9)	7700 (530)	3800 (261)
3/4	-TMT-MR12	1.67 (42.4)	1.06 (27.0)	0.75 (19.1)	0.62 (15.7)	7300 (502)	3600 (248)
1	-TMT-MR16	1.94 (49.3)	1.37 (34.9)	0.94 (23.9)	0.88 (22.4)	5300 (365)	2600 (179)
1 1/4	-TMT-MR20	2.22 (56.4)	1.69 (42.9)	0.94 (23.9)	1.09 (27.7)	6000 (410)	3000 (200)
1 1/2	-TMT-MR24	2.64 (67.1)	1.87 (47.6)	1.03 (26.2)	1.34 (34.0)	5000 (344)	2500 (172)

Male Crosses

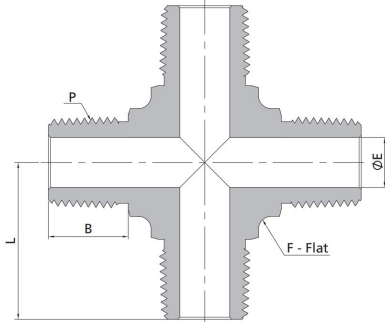

Male NPT Threads							
P-NPT Size	Basic Ordering Number	Dimension,in(mm)				Working Pressure psig(bar)	
		L	F (Hex)	B	E	316SS,Steel	Brass
1/16	-TMC-MN1	0.72 (18.3)	0.37 (9.5)	0.38 (9.7)	0.12 (3.0)	11000 (757)	5500 (378)
1/8	-TMC-MN2	0.88 (22.4)	0.44 (11.1)	0.38 (9.7)	0.19 (4.8)	10000 (689)	5000 (344)
1/4	-TMC-MN4	1.05 (26.7)	0.50 (12.7)	0.56 (14.2)	0.28 (7.1)	8000 (551)	4000 (275)
3/8	-TMC-MN6	1.17 (29.7)	0.69 (17.5)	0.56 (14.2)	0.38 (9.6)	7800 (537)	3900 (268)
1/2	-TMC-MN8	1.45 (36.8)	0.81 (20.6)	0.75 (19.1)	0.47 (11.9)	7700 (530)	3800 (261)
3/4	-TMC-MN12	1.67 (42.4)	1.06 (27.0)	0.75 (19.1)	0.62 (15.7)	7300 (502)	3600 (248)
1	-TMC-MN16	1.94 (49.3)	1.37 (34.9)	0.94 (23.9)	0.88 (22.4)	5300(365)	2600 (179)
1 1/4	-TMC-MN20	2.22 (56.4)	1.69 (42.9)	0.94 (23.9)	1.09 (27.7)	6000 (410)	3000 (200)
1 1/2	-TMC-MN24	2.64 (67.1)	1.87 (47.6)	1.03 (26.2)	1.34 (34.0)	5000 (344)	2500 (172)

Female Branch Tees

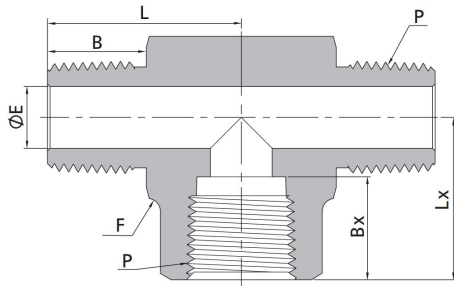

NPT Threads									
P-NPT Size	Basic Ordering Number	Dimension,in(mm)						Working Pressure psig(bar)	
		L	F (Flat)	B	E	Lx	Bx	316SS, Steel	Brass
1/16	-TFB-MN1-FN1	0.72 (18.3)	0.44 (11.1)	0.12 (3.0)	0.38 (9.7)	0.86 (21.8)	0.39 (9.9)	9200 (633)	4600 (316)
1/8	-TFB-MN2-FN2	0.87 (22.1)	0.50 (12.7)	0.19 (4.8)	0.38 (9.7)	1.04 (26.4)	0.41 (10.4)	6200 (427)	3100 (213)
1/4	-TFB-MN4-FN4	1.17 (29.7)	0.69 (17.5)	0.28 (7.1)	0.56 (14.2)	1.17 (29.7)	0.59 (15.0)	7200 (496)	3600 (248)
3/8	-TFB-MN6-FN6	1.26 (32.0)	0.81 (20.6)	0.38 (9.6)	0.56 (14.2)	1.42 (36.1)	0.59 (15.0)	5600 (385)	2800 (192)
1/2	-TFB-MN8-FN8	1.56 (39.6)	1.00 (25.4)	0.47 (11.9)	0.75 (19.1)	1.56 (39.6)	0.78 (19.8)	5600 (385)	2800 (192)
3/4	-TFB-MN12-FN12	1.67 (42.4)	1.25 (31.8)	0.62 (15.7)	0.75 (19.1)	1.92 (48.8)	0.81 (20.6)	5100 (351)	2500 (172)
1	-TFB-MN16-FN16	1.94 (49.3)	1.69 (42.9)	0.88 (22.4)	0.94 (23.9)	1.91 (48.5)	1.00 (25.4)	5300 (365)	2600 (179)

ISO Tapered Threads									
P-RT Size	Basic Ordering Number	Dimension,in(mm)						Working Pressure psig(bar)	
		L	F (Flat)	B	E	Lx	Bx	316SS, Steel	Brass
1/16	-TFB-MR1-FR1	0.72 (18.3)	0.44 (11.1)	0.12 (3.0)	0.38 (9.7)	0.86 (21.8)	0.39 (9.9)	9200 (633)	4600 (316)
1/8	-TFB-MR2-FR2	0.87 (22.1)	0.50 (12.7)	0.19 (4.8)	0.38 (9.7)	1.04 (26.4)	0.41 (10.4)	6200 (427)	3100 (213)
1/4	-TFB-MR4-FR4	1.17 (29.7)	0.69 (17.5)	0.28 (7.1)	0.56 (14.2)	1.17 (29.7)	0.59 (15.0)	7200 (496)	3600 (248)
3/8	-TFB-MR6-FR6	1.26 (32.0)	0.81 (20.6)	0.38 (9.6)	0.56 (14.2)	1.42 (36.1)	0.59 (15.0)	5600 (385)	2800 (192)
1/2	-TFB-MR8-FR8	1.56 (39.6)	1.00 (25.4)	0.47 (11.9)	0.75 (19.1)	1.56 (39.6)	0.78 (19.8)	5600 (385)	2800 (192)
3/4	-TFB-MR12-FR12	1.67 (42.4)	1.25 (31.8)	0.62 (15.7)	0.75 (19.1)	1.92 (48.8)	0.81 (20.6)	5100 (351)	2500 (172)
1	-TFB-MR16-FR16	1.94 (49.3)	1.69 (42.9)	0.88 (22.4)	0.94 (23.9)	1.91 (48.5)	1.00 (25.4)	5300 (365)	2600 (179)

Female Run Tees

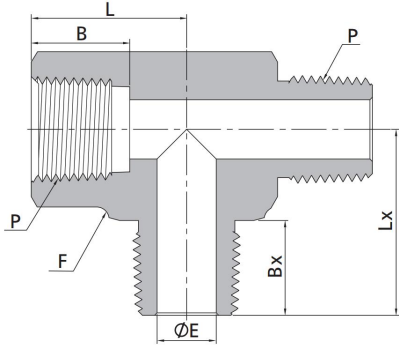

NPT Threads									
P-NPT Size	Basic Ordering Number	Dimension, in(mm)						Working Pressure psig(bar)	
		L	F (Flat)	B	E	Lx	Bx	316SS, Steel	Brass
1/16	-TFR-MN1-FN1	0.86(21.8)	0.44 (11.1)	0.12 (3.0)	0.38 (9.7)	0.86 (21.8)	0.39 (9.9)	9200 (633)	4600 (316)
1/8	-TFR-MN2-FN2	1.04 (26.4)	0.50 (12.7)	0.19 (4.8)	0.41 (10.4)	0.87 (22.1)	0.38 (9.7)	6200 (427)	3100 (213)
1/4	-TFR-MN4-FN4	1.17 (29.7)	0.69 (17.5)	0.28 (7.1)	0.59 (15.0)	1.17 (29.7)	0.56 (14.2)	7200 (496)	3600 (248)
3/8	-TFR-MN6-FN6	1.42 (36.1)	0.81 (20.6)	0.38 (9.6)	0.59 (15.0)	1.26 (32.0)	0.56 (14.2)	5600 (385)	2800 (192)
1/2	-TFR-MN8-FN8	1.56 (39.6)	1.00 (25.4)	0.47 (11.9)	0.78 (19.8)	1.56 (39.6)	0.75 (19.1)	5600 (385)	2800 (192)
3/4	-TFR-MN12-FN12	1.92 (48.8)	1.25 (31.8)	0.62 (15.7)	0.81 (20.6)	1.67 (42.4)	0.75 (19.1)	5100 (351)	2500 (172)
1	-TFR-MN16-FN16	1.91 (48.5)	1.69 (42.9)	0.88 (22.4)	1.00 (25.4)	1.94 (49.3)	0.94 (23.9)	5300 (365)	2600 (179)

ISO Tapered Threads									
P-RT Size	Basic Ordering Number	Dimension, in(mm)						Working Pressure psig(bar)	
		L	F (Flat)	B	E	Lx	Bx	316SS, Steel	Brass
1/16	-TFR-MR1-FR1	0.86(21.8)	0.44 (11.1)	0.12 (3.0)	0.38 (9.7)	0.86 (21.8)	0.39 (9.9)	9200 (633)	4600 (316)
1/8	-TFR-MR2-FR2	1.04 (26.4)	0.50 (12.7)	0.19 (4.8)	0.41 (10.4)	0.87 (22.1)	0.38 (9.7)	6200 (427)	3100 (213)
1/4	-TFR-MR4-FR4	1.17 (29.7)	0.69 (17.5)	0.28 (7.1)	0.59 (15.0)	1.17 (29.7)	0.56 (14.2)	7200 (496)	3600 (248)
3/8	-TFR-MR6-FR6	1.42 (36.1)	0.81 (20.6)	0.38 (9.6)	0.59 (15.0)	1.26 (32.0)	0.56 (14.2)	5600 (385)	2800 (192)
1/2	-TFR-MR8-FR8	1.56 (39.6)	1.00 (25.4)	0.47 (11.9)	0.78 (19.8)	1.56 (39.6)	0.75 (19.1)	5600 (385)	2800 (192)
3/4	-TFR-MR12-FR12	1.92 (48.8)	1.25 (31.8)	0.62 (15.7)	0.81 (20.6)	1.67 (42.4)	0.75 (19.1)	5100 (351)	2500 (172)
1	-TFR-MR16-FR16	1.91 (48.5)	1.69 (42.9)	0.88 (22.4)	1.00 (25.4)	1.94 (49.3)	0.94 (23.9)	5300 (365)	2600 (179)

Male Street Tees

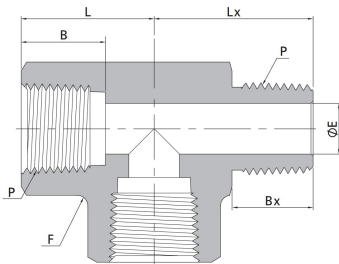

NPT Threads									
P-NPT Size	Basic Ordering Number	Dimension, in(mm)						Working Pressure psig(bar)	
		L	F (Flat)	B	E	Lx	Bx	316SS, Steel	Brass
1/16	-TMS-FN1-MN1	0.86(21.8)	0.44 (11.1)	0.12 (3.0)	0.38 (9.7)	0.86 (21.8)	0.39 (9.9)	9200 (633)	4600 (316)
1/8	-TMS-FN2-MN2	1.04 (26.4)	0.50 (12.7)	0.19 (4.8)	0.41 (10.4)	0.87 (22.1)	0.38 (9.7)	6200 (427)	3100 (213)
1/4	-TMS-FN4-MN4	1.17 (29.7)	0.69 (17.5)	0.28 (7.1)	0.59 (15.0)	1.17 (29.7)	0.56 (14.2)	7200 (496)	3600 (248)
3/8	-TMS-FN6-MN6	1.42 (36.1)	0.81 (20.6)	0.38 (9.6)	0.59 (15.0)	1.26 (32.0)	0.56 (14.2)	5600 (385)	2800 (192)
1/2	-TMS-FN8-MN8	1.56 (39.6)	1.00 (25.4)	0.47 (11.9)	0.78 (19.8)	1.56 (39.6)	0.75 (19.1)	5600 (385)	2800 (192)
3/4	-TMS-FN12-MN12	1.92 (48.8)	1.25 (31.8)	0.62 (15.7)	0.81 (20.6)	1.67 (42.4)	0.75 (19.1)	5100 (351)	2500 (172)
1	-TMS-FN16-MN16	1.91 (48.5)	1.69 (42.9)	0.88 (22.4)	1.00 (25.4)	1.94 (49.3)	0.94 (23.9)	5300 (365)	2600 (179)

20 Pipe Fittings

ISO Tapered Threads									
P-RT Size	Basic Ordering Number	Dimension, in(mm)						Working Pressure psig(bar)	
		L	F (Flat)	B	E	Lx	Bx	316SS, Steel	Brass
1/16	-TMS-FR1-MR1	0.86(21.8)	0.44 (11.1)	0.12 (3.0)	0.38 (9.7)	0.86 (21.8)	0.39 (9.9)	9200 (633)	4600 (316)
1/8	-TMS-FR2-MR2	1.04 (26.4)	0.50 (12.7)	0.19 (4.8)	0.41 (10.4)	0.87 (22.1)	0.38 (9.7)	6200 (427)	3100 (213)
1/4	-TMS-FR4-MR4	1.17 (29.7)	0.69 (17.5)	0.28 (7.1)	0.59 (15.0)	1.17 (29.7)	0.56 (14.2)	7200 (496)	3600 (248)
3/8	-TMS-FR6-MR6	1.42 (36.1)	0.81 (20.6)	0.38 (9.6)	0.59 (15.0)	1.26 (32.0)	0.56 (14.2)	5600 (385)	2800 (192)
1/2	-TMS-FR8-MR8	1.56 (39.6)	1.00 (25.4)	0.47 (11.9)	0.78 (19.8)	1.56 (39.6)	0.75 (19.1)	5600 (385)	2800 (192)
3/4	-TMS-FR12-MR12	1.92 (48.8)	1.25 (31.8)	0.62 (15.7)	0.81 (20.6)	1.67 (42.4)	0.75 (19.1)	5100 (351)	2500 (172)
1	-TMS-FR16-MR16	1.91 (48.5)	1.69 (42.9)	0.88 (22.4)	1.00 (25.4)	1.94 (49.3)	0.94 (23.9)	5300 (365)	2600 (179)

Male Branch Tees

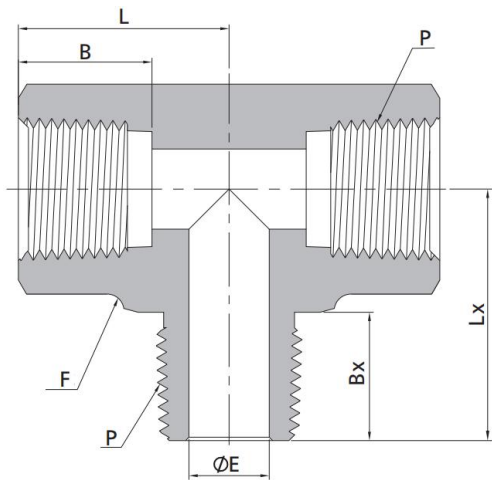

NPT Threads									
P-NPT Size	Basic Ordering Number	Dimension, in(mm)						Working Pressure psig(bar)	
		L	F (Flat)	B	E	Lx	Bx	316SS, Steel	Brass
1/16	-TMB-FN1-MN1	0.86(21.8)	0.44 (11.1)	0.12 (3.0)	0.38 (9.7)	0.86 (21.8)	0.39 (9.9)	9200 (633)	4600 (316)
1/8	-TMB-FN2-MN2	1.04 (26.4)	0.50 (12.7)	0.19 (4.8)	0.41 (10.4)	0.87 (22.1)	0.38 (9.7)	6200 (427)	3100 (213)
1/4	-TMB-FN4-MN4	1.17 (29.7)	0.69 (17.5)	0.28 (7.1)	0.59 (15.0)	1.17 (29.7)	0.56 (14.2)	7200 (496)	3600 (248)
3/8	-TMB-FN6-MN6	1.42 (36.1)	0.81 (20.6)	0.38 (9.6)	0.59 (15.0)	1.26 (32.0)	0.56 (14.2)	5600 (385)	2800 (192)
1/2	-TMB-FN8-MN8	1.56 (39.6)	1.00 (25.4)	0.47 (11.9)	0.78 (19.8)	1.56 (39.6)	0.75 (19.1)	5600 (385)	2800 (192)
3/4	-TMB-FN12-MN12	1.92 (48.8)	1.25 (31.8)	0.62 (15.7)	0.81 (20.6)	1.67 (42.4)	0.75 (19.1)	5100 (351)	2500 (172)
1	-TMB-FN16-MN16	1.91 (48.5)	1.69 (42.9)	0.88 (22.4)	1.00 (25.4)	1.94 (49.3)	0.94 (23.9)	5300 (365)	2600 (179)

ISO Tapered Threads									
P-RT Size	Basic Ordering Number	Dimension, in(mm)						Working Pressure psig(bar)	
		L	F (Flat)	B	E	Lx	Bx	316SS, Steel	Brass
1/16	-TMB-FR1-MR1	0.86(21.8)	0.44 (11.1)	0.12 (3.0)	0.38 (9.7)	0.86 (21.8)	0.39 (9.9)	9200 (633)	4600 (316)
1/8	-TMB-FR2-MR2	1.04 (26.4)	0.50 (12.7)	0.19 (4.8)	0.41 (10.4)	0.87 (22.1)	0.38 (9.7)	6200 (427)	3100 (213)
1/4	-TMB-FR4-MR4	1.17 (29.7)	0.69 (17.5)	0.28 (7.1)	0.59 (15.0)	1.17 (29.7)	0.56 (14.2)	7200 (496)	3600 (248)
3/8	-TMB-FR6-MR6	1.42 (36.1)	0.81 (20.6)	0.38 (9.6)	0.59 (15.0)	1.26 (32.0)	0.56 (14.2)	5600 (385)	2800 (192)
1/2	-TMB-FR8-MR8	1.56 (39.6)	1.00 (25.4)	0.47 (11.9)	0.78 (19.8)	1.56 (39.6)	0.75 (19.1)	5600 (385)	2800 (192)
3/4	-TMB-FR12-MR12	1.92 (48.8)	1.25 (31.8)	0.62 (15.7)	0.81 (20.6)	1.67 (42.4)	0.75 (19.1)	5100 (351)	2500 (172)
1	-TMB-FR16-MR16	1.91 (48.5)	1.69 (42.9)	0.88 (22.4)	1.00 (25.4)	1.94 (49.3)	0.94 (23.9)	5300 (365)	2600 (179)

Female Tees

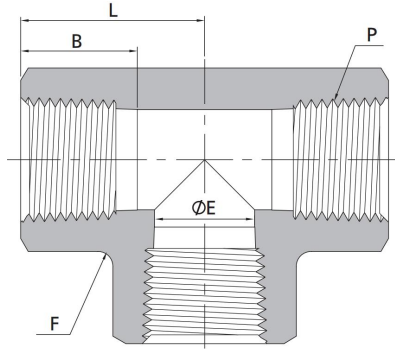

Female NPT Threads							
P-NPT Size	Basic Ordering Number	Dimension,in(mm)				Working Pressure psig(bar)	
		L	F (Flat)	B	E	316SS, Steel	Brass
1/16	-TFT-FN1	0.86 (21.8)	0.44(11.1)	0.39 (9.9)	0.19(4.8)	6700 (460)	3300 (227)
1/8	-TFT-FN2	1.04 (26.4)	0.50 (12.7)	0.41 (10.4)	0.34 (8.6)	6200 (427)	3100 (213)
1/4	-TFT-FN4	1.17(29.7)	0.69 (17.5)	0.59 (15.0)	0.45 (11.4)	7200 (496)	3600 (248)
3/8	-TFT-FN6	1.42 (36.1)	0.81 (20.6)	0.59(15.0)	0.59 (15.0)	5600 (385)	2800 (192)
1/2	-TFT-FN8	1.56 (39.6)	1.00 (25.4)	0.78 (19.8)	0.73 (18.5)	5600 (385)	2800 (192)
3/4	-TFT-FN12	1.92 (48.8)	1.25 (31.8)	0.81 (20.6)	0.94 (23.9)	5100 (351)	2500 (172)
1	-TFT-FN16	1.91 (48.5)	1.69(42.9)	1.00 (25.4)	1.17(29.7)	6400 (440)	3200 (220)
1 1/4	-TFT-FN20	2.35 (59.8)	2.00 (50.8)	1.00(25.4)	1.46 (37.2)	3100 (213)	1600 (110)
1 1/2	-TFT-FN24	2.56 (65.0)	2.50 (63.5)	1.09 (27.7)	1.70(43.3)	5100 (351)	2500 (172)
Heavy-Wall Female NPT Threads							
1/16	-TFT-FN1-10K	1.04 (26.4)	0.50 (12.7)	0.39 (9.9)	0.19(4.8)	10000 (689)	-
1/8	-TFT-FN2-10K	1.17(29.7)	0.69 (17.5)	0.41 (10.4)	0.34 (8.6)	10000 (689)	-
1/4	-TFT-FN4-10K	1.56 (39.6)	1.00 (25.4)	0.59(15.0)	0.45 (11.4)	10000 (689)	-
3/8	-TFT-FN6-10K	1.56 (39.6)	1.00 (25.4)	0.59(15.0)	0.59 (15.0)	10000 (689)	-
1/2	-TFT-FN8-10K	1.97 (50.0)	1.69(42.9)	0.78 (19.8)	0.73 (18.5)	10000 (689)	-
3/4	-TFT-FN12-10K	1.91 (48.5)	1.69(42.9)	0.81 (20.6)	0.94 (23.9)	10000 (689)	-
1	-TFT-FN16-10K	2.35 (59.8)	2.00 (50.8)	1.00 (25.4)	1.17(29.7)	10000 (689)	-
Female ISO Tapered Threads							
P-RT Size	Basic Ordering Number	Dimension,in(mm)				Working Pressure psig(bar)	
		L	F (Flat)	B	E	316SS, Steel	Brass
1/16	-TFT-FR1	0.86 (21.8)	0.44(11.1)	0.39 (9.9)	0.19(4.8)	6700 (460)	3300 (227)
1/8	-TFT-FR2	1.04 (26.4)	0.50 (12.7)	0.41 (10.4)	0.34 (8.6)	6200 (427)	3100 (213)
1/4	-TFT-FR4	1.17(29.7)	0.69 (17.5)	0.59 (15.0)	0.45 (11.4)	7200 (496)	3600 (248)
3/8	-TFT-FR6	1.42 (36.1)	0.81 (20.6)	0.59(15.0)	0.59 (15.0)	5600 (385)	2800 (192)
1/2	-TFT-FR8	1.56 (39.6)	1.00 (25.4)	0.78 (19.8)	0.73 (18.5)	5600 (385)	2800 (192)
3/4	-TFT-FR12	1.92 (48.8)	1.25 (31.8)	0.81 (20.6)	0.94 (23.9)	5100 (351)	2500 (172)
1	-TFT-FR16	1.91 (48.5)	1.69(42.9)	1.00 (25.4)	1.17(29.7)	6400 (440)	3200 (220)
1 1/4	-TFT-FR20	2.35 (59.8)	2.00 (50.8)	1.00(25.4)	1.46 (37.2)	3100 (213)	1600 (110)
1 1/2	-TFT-FR24	2.56 (65.0)	2.50 (63.5)	1.09 (27.7)	1.70(43.3)	5100 (351)	2500 (172)

Female Crosses

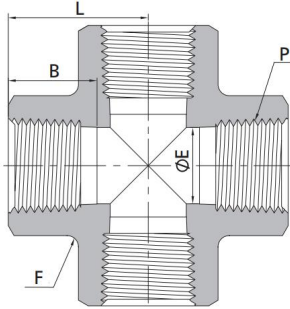

Female NPT Threads							
P-NPT Size	Basic Ordering Number	Dimension,in(mm)				Working Pressure psig(bar)	
		L	F (Flat)	B	E	316SS, Steel	Brass
1/16	-TFC-FN1	0.86 (21.8)	0.44(11.1)	0.39 (9.9)	0.19(4.8)	6700 (460)	3300 (227)
1/8	-TFC-FN2	1.04 (26.4)	0.50 (12.7)	0.41 (10.4)	0.34 (8.6)	6200 (427)	3100 (213)
1/4	-TFC-FN4	1.17(29.7)	0.69 (17.5)	0.59 (15.0)	0.45 (11.4)	7200 (496)	3600 (248)
3/8	-TFC-FN6	1.42 (36.1)	0.81 (20.6)	0.59(15.0)	0.59 (15.0)	5600 (385)	2800 (192)
1/2	-TFC-FN8	1.56 (39.6)	1.00 (25.4)	0.78 (19.8)	0.73 (18.5)	5600 (385)	2800 (192)
3/4	-TFC-FN12	1.92 (48.8)	1.25 (31.8)	0.81 (20.6)	0.94 (23.9)	5100 (351)	2500 (172)
1	-TFC-FN16	1.91 (48.5)	1.69(42.9)	1.00 (25.4)	1.17(29.7)	6400 (440)	3200 (220)
1 1/4	-TFC-FN20	2.35 (59.8)	2.00 (50.8)	1.00(25.4)	1.46 (37.2)	3100 (213)	1600 (110)
1 1/2	-TFC-FN24	2.56 (65.0)	2.50 (63.5)	1.09 (27.7)	1.70(43.3)	5100 (351)	2500 (172)

Female ISO Tapered Threads							
P-RT Size	Basic Ordering Number	Dimension,in(mm)				Working Pressure psig(bar)	
		L	F (Flat)	B	E	316SS, Steel	Brass
1/16	-TFC-FR1	0.86 (21.8)	0.44(11.1)	0.39 (9.9)	0.19(4.8)	6700 (460)	3300 (227)
1/8	-TFC-FR2	1.04 (26.4)	0.50 (12.7)	0.41 (10.4)	0.34 (8.6)	6200 (427)	3100 (213)
1/4	-TFC-FR4	1.17(29.7)	0.69 (17.5)	0.59 (15.0)	0.45 (11.4)	7200 (496)	3600 (248)
3/8	-TFC-FR6	1.42 (36.1)	0.81 (20.6)	0.59(15.0)	0.59 (15.0)	5600 (385)	2800 (192)
1/2	-TFC-FR8	1.56 (39.6)	1.00 (25.4)	0.78 (19.8)	0.73 (18.5)	5600 (385)	2800 (192)
3/4	-TFC-FR12	1.92 (48.8)	1.25 (31.8)	0.81 (20.6)	0.94 (23.9)	5100 (351)	2500 (172)
1	-TFC-FR16	1.91 (48.5)	1.69(42.9)	1.00 (25.4)	1.17(29.7)	6400 (440)	3200 (220)
1 1/4	-TFC-FR20	2.35 (59.8)	2.00 (50.8)	1.00(25.4)	1.46 (37.2)	3100 (213)	1600 (110)
1 1/2	-TFC-FR24	2.56 (65.0)	2.50 (63.5)	1.09 (27.7)	1.70(43.3)	5100 (351)	2500 (172)

Pipe Caps

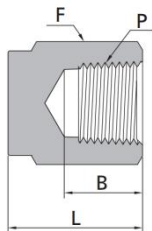

Male NPT Threads					Male ISO Parallel Threads				
P-NPT Size	Basic Ordering Number	Dimension,in(mm)			P-RT Size	Basic Ordering Number	Dimension,in(mm)		
		L	F (Hex)	B			L	F (Hex)	B
1/16	-TPC-FN1	0.50 (12.7)	0.44 (11.1)	0.39 (9.9)	1/16	-TPC-FR1	0.50 (12.7)	0.44 (11.1)	0.39 (9.9)
1/8	-TPC-FN2	0.75 (19.1)	0.56 (14.3)	0.41 (10.4)	1/8	-TPC-FR2	0.75 (19.1)	0.56 (14.3)	0.41 (10.4)
1/4	-TPC-FN4	0.91 (23.1)	0.75 (19.1)	0.59 (15.0)	1/4	-TPC-FR4	0.91 (23.1)	0.75 (19.1)	0.59 (15.0)
3/8	-TPC-FN6	1.03 (26.2)	0.87 (22.2)	0.59 (15.0)	3/8	-TPC-FR6	1.03 (26.2)	0.87 (22.2)	0.59 (15.0)
1/2	-TPC-FN8	1.34 (34.0)	1.06 (27.0)	0.78 (19.8)	1/2	-TPC-FR8	1.34 (34.0)	1.06 (27.0)	0.78 (19.8)
3/4	-TPC-FN12	1.44 (36.6)	1.31 (33.3)	0.81 (20.6)	3/4	-TPC-FR12	1.44 (36.6)	1.31 (33.3)	0.81 (20.6)
1	-TPC-FN16	1.62 (41.1)	1.63 (41.3)	1.00 (25.4)	1	-TPC-FR16	1.62 (41.1)	1.63 (41.3)	1.00 (25.4)

Pipe Plugs

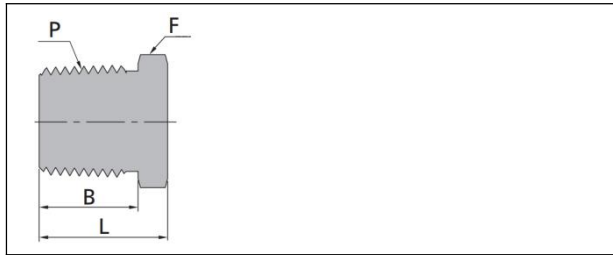

Male NPT Threads

P-NPT Size	Basic Ordering Number	Dimension, in(mm)		
		L	F (Hex)	B
1/16	-TPP-MN1	0.56 (14.2)	0.31 (7.9)	038 (9.7)
1/8	-TPP-MN2	0.56 (14.2)	0.44 (11.1)	038 (9.7)
1/4	-TPP-MN4	0.75 (19.1)	0.56 (14.3)	0.56 (14.2)
3/8	-TPP-MN6	0.78 (19.8)	0.69 (17.5)	0.56 (14.2)
1/2	-TPP-MN8	0.97 (24.6)	0.87 (22.2)	0.75 (19.1)
3/4	-TPP-MN12	1.21 (30.7)	1.06 (27.0)	0.75 (19.1)
1	-TPP-MN16	1.50 (38.1)	1.37 (34.9)	0.94 (23.9)
1 1/4	-TPP-MN20	1-51(38.4)	1.75 (44.5)	0.94 (23.9)
1 1/2	-TPP-MN24	1.72 (43.7)	2.00 (50.8)	1.03 (26.2)

Male ISO Tapered Threads

P-RT Size	Basic Ordering Number	Dimension, in(mm)		
		L	F (Hex)	B
1/16	-TPP-MR1	0.56 (14.2)	0.31 (7.9)	038 (9.7)
1/8	-TPP-MR2	0.56 (14.2)	0.44 (11.1)	038 (9.7)
1/4	-TPP-MR4	0.75 (19.1)	0.56 (14.3)	0.56 (14.2)
3/8	-TPP-MR6	0.78 (19.8)	0.69 (17.5)	0.56 (14.2)
1/2	-TPP-MR8	0.97 (24.6)	0.87 (22.2)	0.75 (19.1)
3/4	-TPP-MR12	1.21 (30.7)	1.06 (27.0)	0.75 (19.1)
1	-TPP-MR16	1.50 (38.1)	1.37 (34.9)	0.94 (23.9)
1 1/4	-TPP-MR20	1-51(38.4)	1.75 (44.5)	0.94 (23.9)
1 1/2	-TPP-MR24	1.72 (43.7)	2.00 (50.8)	1.03 (26.2)
2	-TPP-MR32	2.00 (50.8)	2.75 (69.9)	1.03 (26.2)

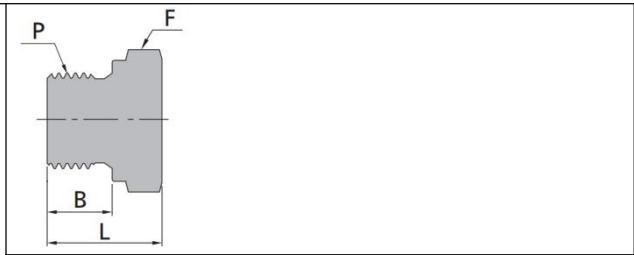

Male ISO Parallel Threads

P-RS Size	Basic Ordering Number	Dimension, in(mm)		
		L	F (Hex)	B
1/8	-TPP-RS2	0.55 (14.0)	0.56 (14.3)	0.28 (7.1)
1/4	-TPP-RS4	0.78 (19.8)	0.75 (19.1)	0.44 (11.2)
3/8	-TPP-RS6	0.78 (19.8)	0.87 (22.2)	0.44 (11.2)
1/2	-TPP-RS8	0.99 (25.1)	1.06 (27.0)	0.55 (14.0)
3/4	-TPP-RS12	1.13 (28.7)	1.31 (33.3)	0.62 (15.7)
1	-TPP-RS16	1.21 (30.7)	1.63 (41.3)	0.71 (18.0)

Male Metric Threads

P-Metric Size	Basic Ordering Number	Dimension, in(mm)		
		L	F (Hex)	B
M14x 1.5	-TPP-M14	21.0 (0.83)	20.6 (0.81)	12.0 (0.47)
M16 x 1.5	-TPP-M16	23.0 (0.91)	22.2 (0.87)	12.0 (0.47)
M18 x 1.5	-TPP-M18	25.0 (0.98)	23.8 (0.94)	12.0 (0.47)
M20 x 1.5	-TPP-M20	26.5 (1.04)	25.4 (1.00)	14.0 (0.55)
M22 x 1.5	-TPP-M22	28.8 (1.13)	28.6 (1.13)	14.0 (0.55)
M24x 1.5	-TPP-M24	29.0 (1.14)	35.0 (1.38)	14.0 (0.55)
M27 x2	-TPP-M27	30.0 (1.18)	36.5 (1.44)	16.0 (0.63)

Hollow Hex Plugs

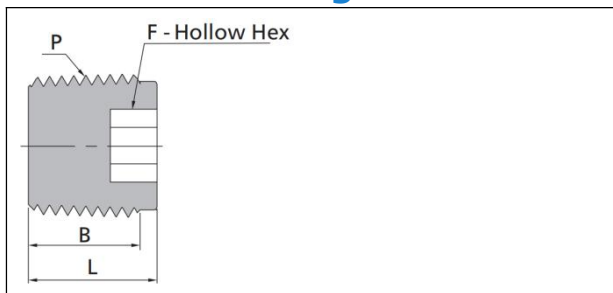

Male NPT Threads

P-NPT Size	Basic Ordering Number	Dimension, in(mm)		
		L	F	B
1/16	-THP-MN1	0.30 (7.6)	0.16 (4.0)	0.29 (7.4)
1/8	-THP-MN2	0.41 (10.4)	0.19 (4.8)	0.29 (7.4)
1/4	-THP-MN4	0.61 (15.5)	0.25 (6.4)	0.49 (12.4)
3/8	-THP-MN6	0.59(15.0)	0.31 (7.9)	0.47 (11.9)
1/2	-THP-MN8	0.76(19.3)	0.37 (9.5)	0.64 (16.2)
3/4	-THP-MN12	0.78(19.8)	0.56 (14.3)	0.66 (16.7)
1	-THP-MN16	0.82 (20.8)	0.63 (15.9)	0.70 (17.7)

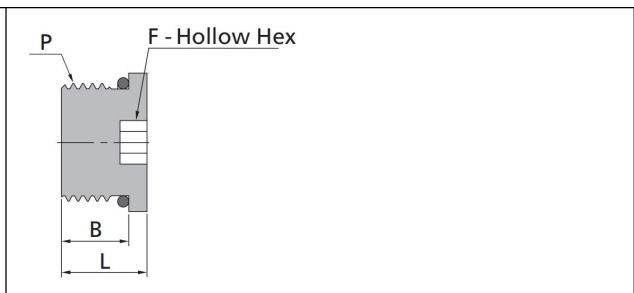

Male ISO Parallel Threads

P-SAE/MS Size	Basic Ordering Number	Dimension, in(mm)		
		L	F	B
7/16-20	-THP-S7	0.45 (11.4)	0.19 (4.8)	0.36 (9.1)
9/16-18	-THP-S9	0.48(12.2)	0.25 (6.4)	0.39 (9.9)
3/4-16	-THP-S12	0.56(14.2)	0.31 (7.9)	0.44(11.2)
1 1/16-12	-THP-S17	0.75(19.1)	0.56 (14.3)	0.59 (15.0)
1 5/16-12	-THP-S21	0.75(19.1)	0.63 (15.9)	0.59 (15.0)

Nantong ROKE Fluid Equipment Co.,LTD

ROKE Factory

Pingchao Town, Tongzhou Area
Nantong City, Jiangsu Province,China
Tel :86-513-86751377
Fax:86-513-86752577

ROKE Office

Room 1108 .Building B. Jianghaicaifudasha
No.817.Jianghai Avenue.Gangzha Area
Nantong City, Jiangsu Province,China
Tel: 86-513-85400443
Fax:86-513-85400444
Web:www.chinaroke.com
E-mail:sales01@ntroke.com

ROKE
Valves and Fittings

www.chinaroke.com